

<p align="center"><b>Notice de pose du faisceau électrique pour crochet d'attelage avec prise 7 voies type 12N</b></p>	<p><b>Version :</b> SEDAN  <b>Année :</b> 03/1999 →  2004  <b>Réf :</b> 164868</p>
<p align="center"><b>Peugeot 406</b></p>	<p align="center"> 0 H 30</p>

Einbauanleitung elektrosatz Anhängervorrichtung mit 12N Steckdose  
Fitting instructions electric wiringkit towbar with 12N socket  
Montage-handleiding elektrokabelset voor trekhaakmet 12N contactos

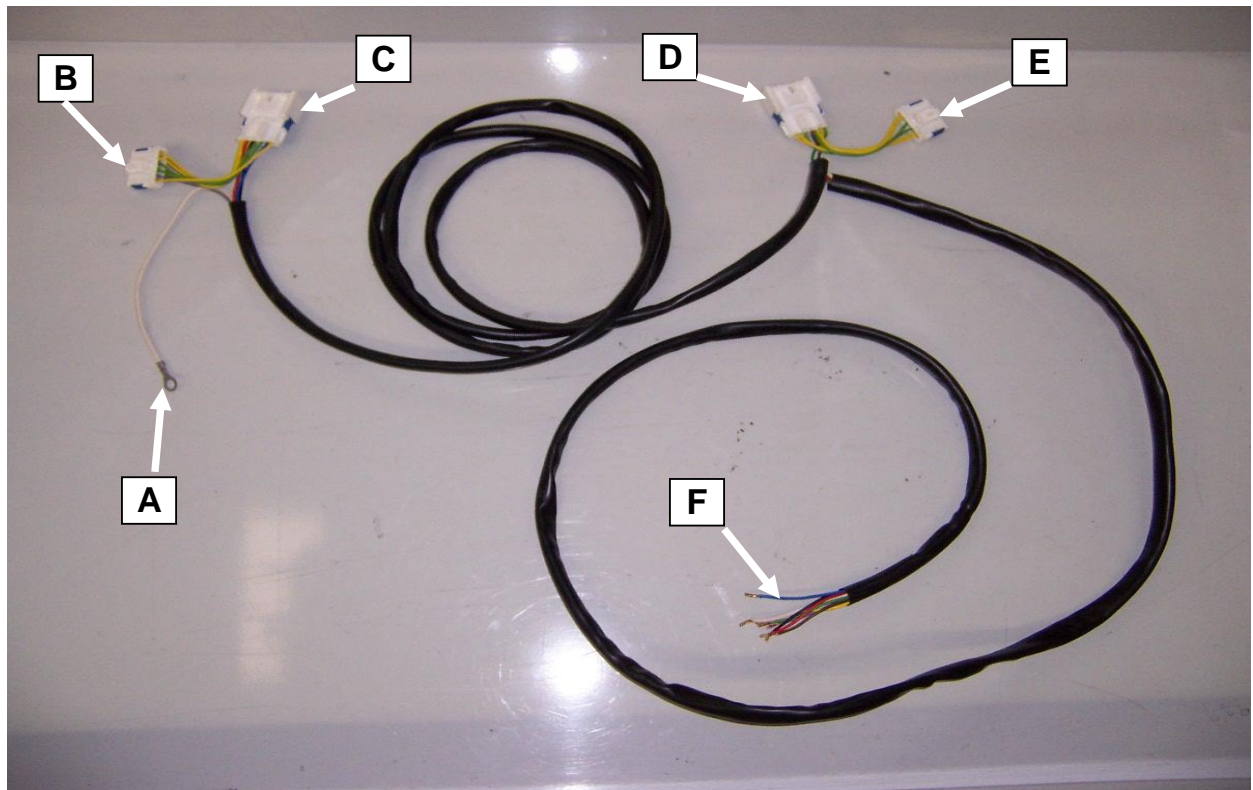

**Liste des pièces / Teilliste / Part list / Onderdelenlijst :**

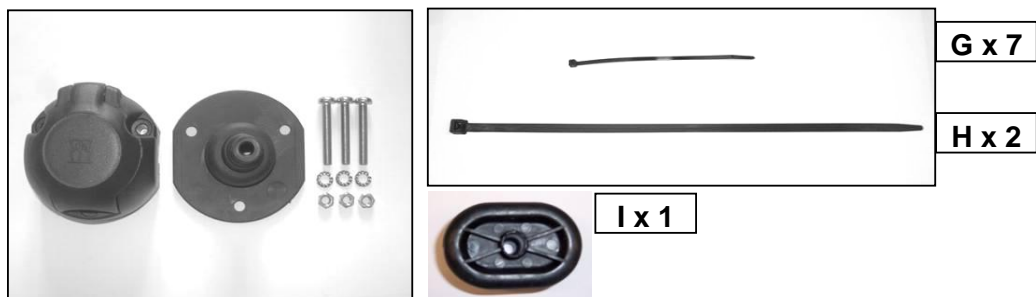

Cette notice ne peut être divulguée ou reproduite, partiellement ou en totalité, sans accord de la société.

1

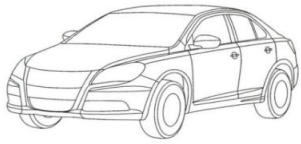

10 min



Code

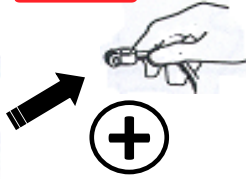
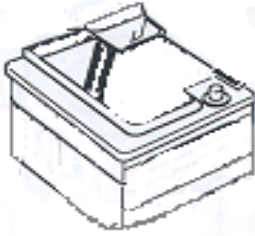

2



3



4



5

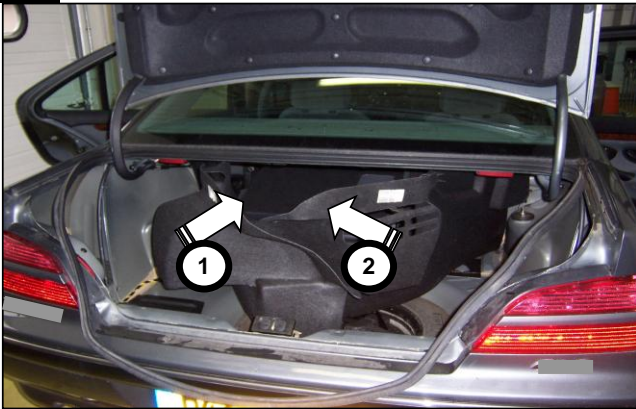

6

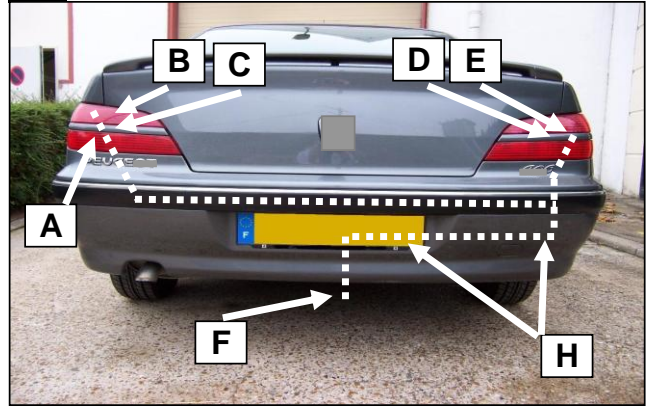

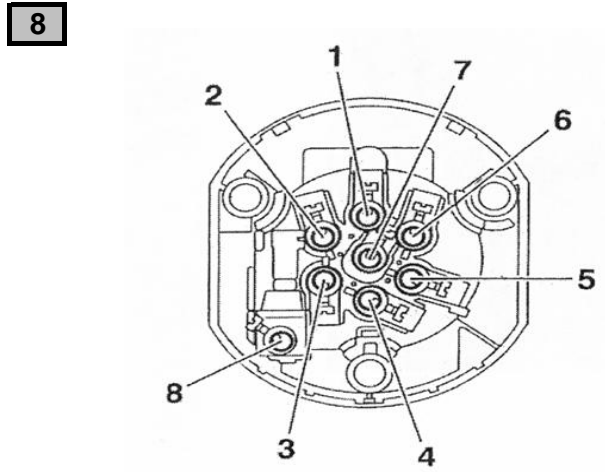
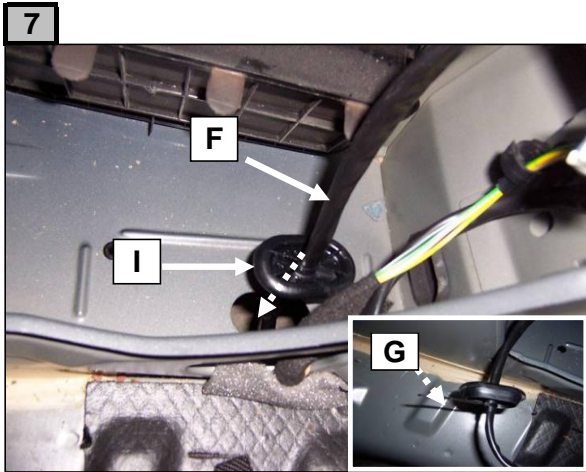

	<b>1/L</b>	<b>2/54g</b>	<b>3/31</b>	<b>4/R</b>	<b>5/58R</b>	<b>6/54</b>	<b>7/58L</b>	<b>8/58B</b>
	21+5 W	21W		21+5 W	40 W	63 W	40 W	
<b>F</b>	Jaune	Bleu	Vert/jaune	Vert	Marron	Rouge	Noir	Gris
<b>D</b>	Gelb	Blau	Grün/gelb	Grün	Braun	Rot	Schwarz	Grau
<b>GB</b>	Yellow	Blue	Green/yellow	Green	Brown	Red	Black	Grey
<b>NL</b>	Geel	Blauw	Groen/geel	Groen	Bruin	Rood	Zwart	Grijs
<b>P</b>	Amarelo	Azul	Verde/amarelo	Verde	Castanho	Vermelho	Preto	Cinzeno
<b>I</b>	Giallo	Blu	Verde/giallo	Verde	Marrone	Rosso	Nero	Grigio
<b>E</b>	Amarillo	Azul	Verde/amarillo	Verde	Marron	Rojo	Negro	Gris

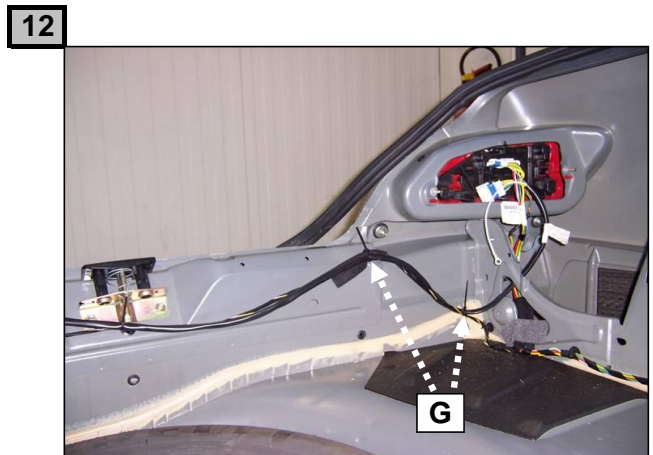
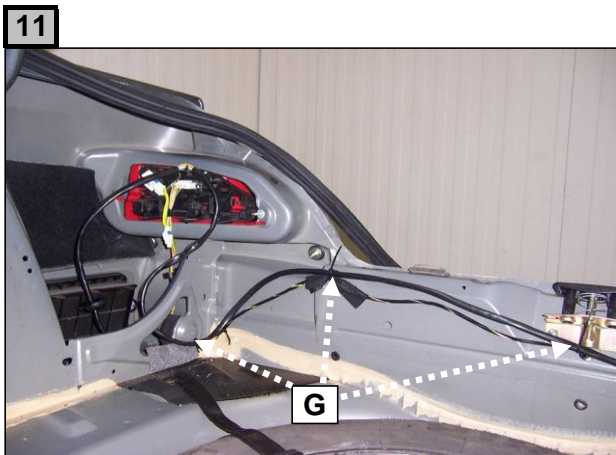
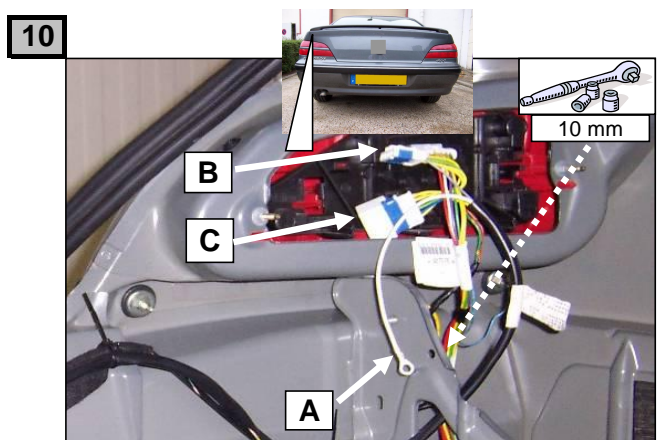
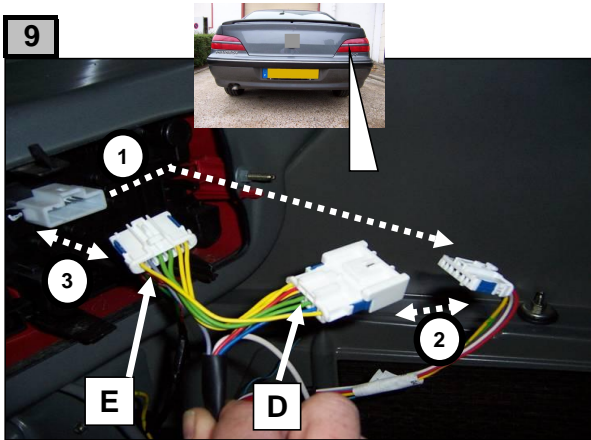

13



14



15



16



17

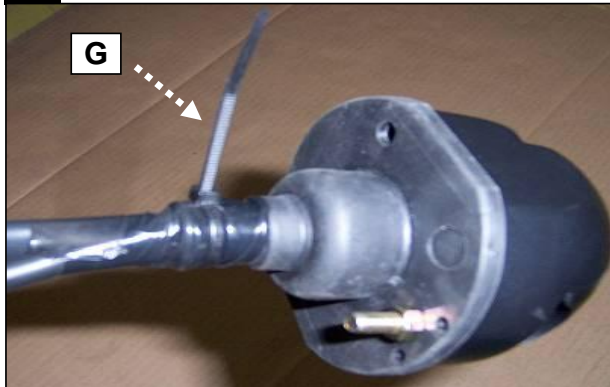

18

! Code

Contrôler les fonctions  
Funktionen kontrollieren  
Check functions  
Controleer functies

OK

 This block contains a warning symbol (exclamation mark in a red triangle) and a 'Code' label. Below is a diagram showing a battery with a plus sign (+) and a hand connecting a cable. To the right, a crossed-out diagram shows an incorrect connection. At the bottom, there is a photograph of a trailer with a motor and the word 'OK' below it.

19

OK

 This block features a technical diagram of a motor assembly at the top. Below it are two side-by-side images of the motor assembly. The left image shows a crossed-out assembly with a warning symbol (exclamation mark in a red triangle). The right image shows the correct assembly with the word 'OK' below it.







