

L = 365

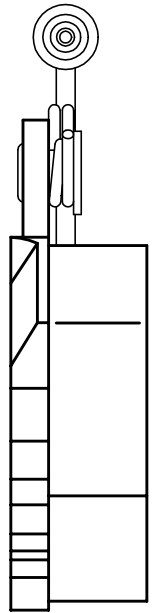

L = 315

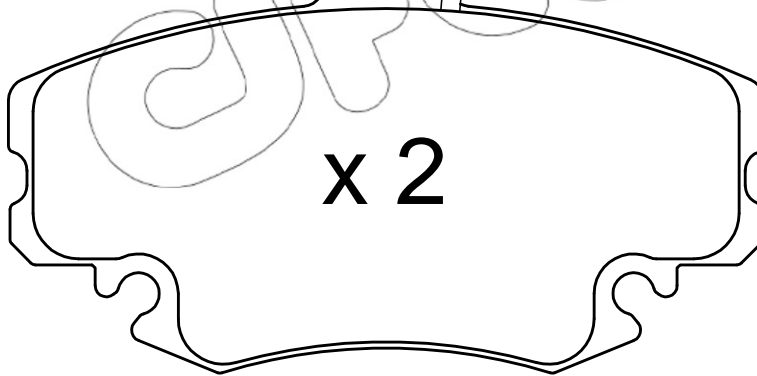