

L = 200

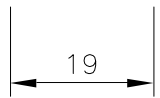
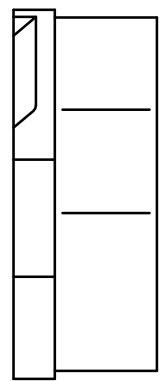
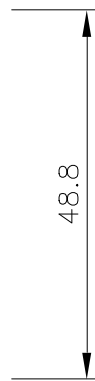
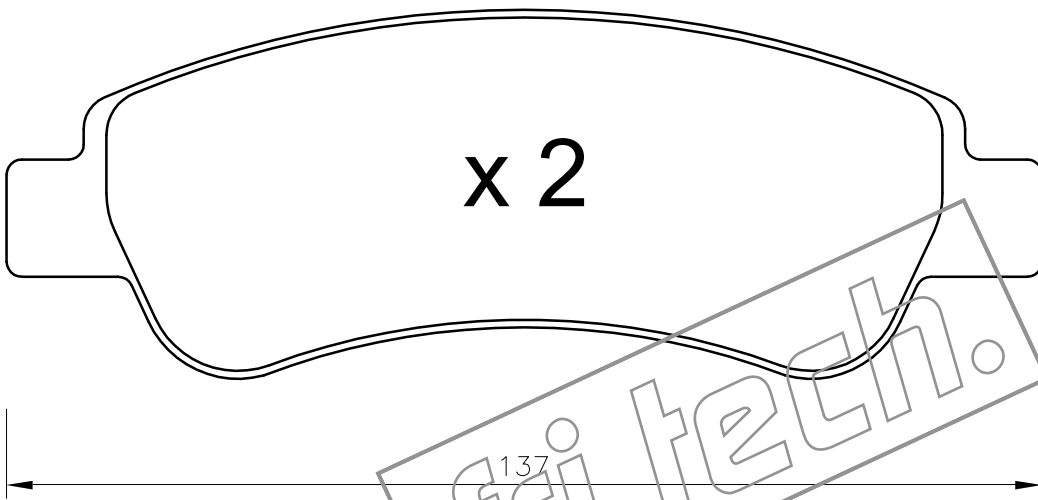
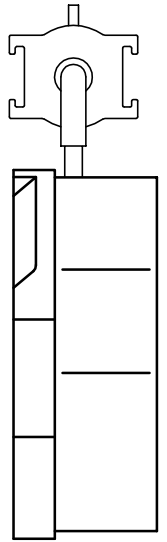
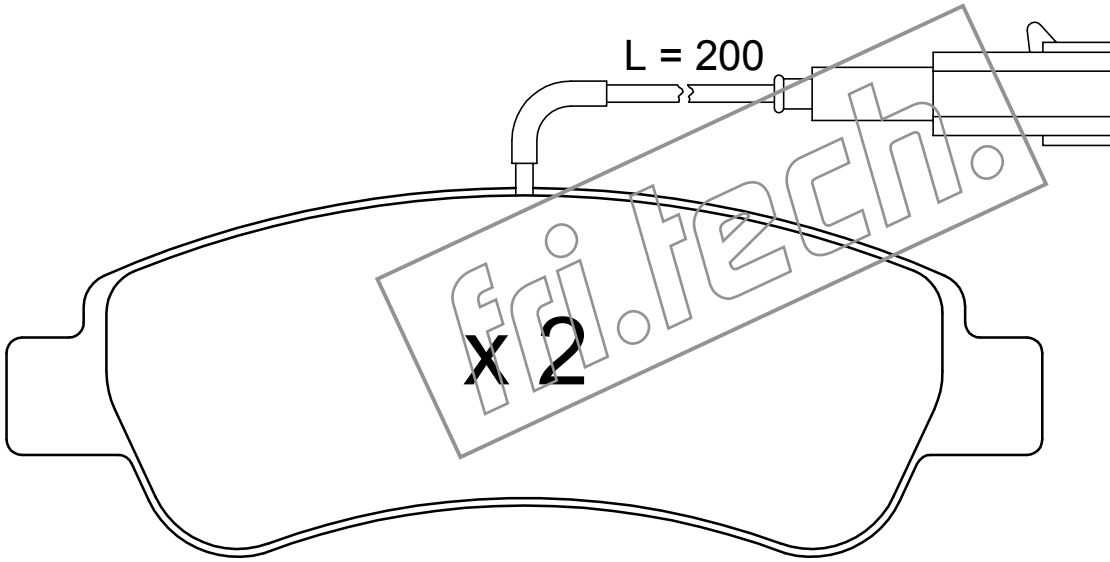

fri.tech.