

L = 170

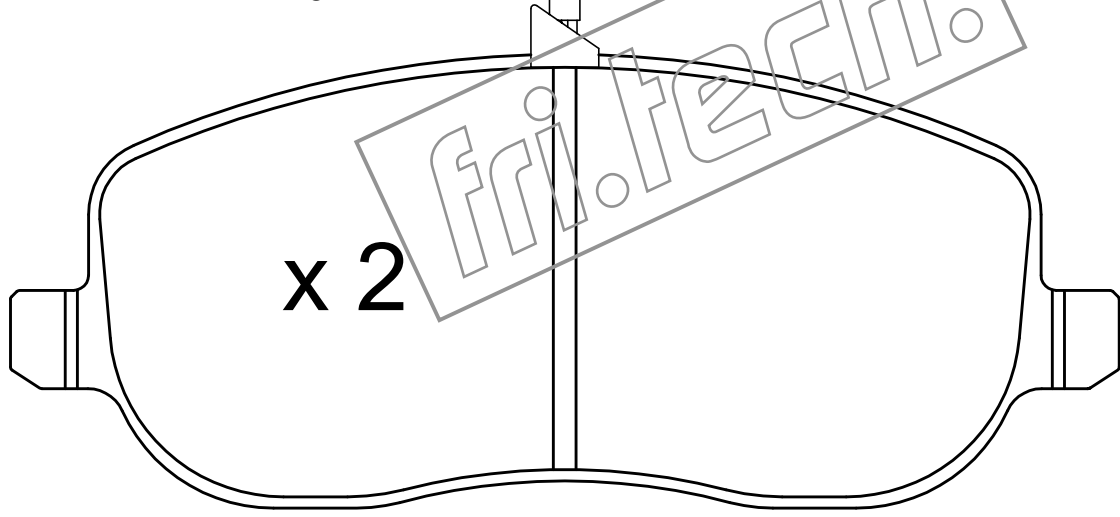

x 2

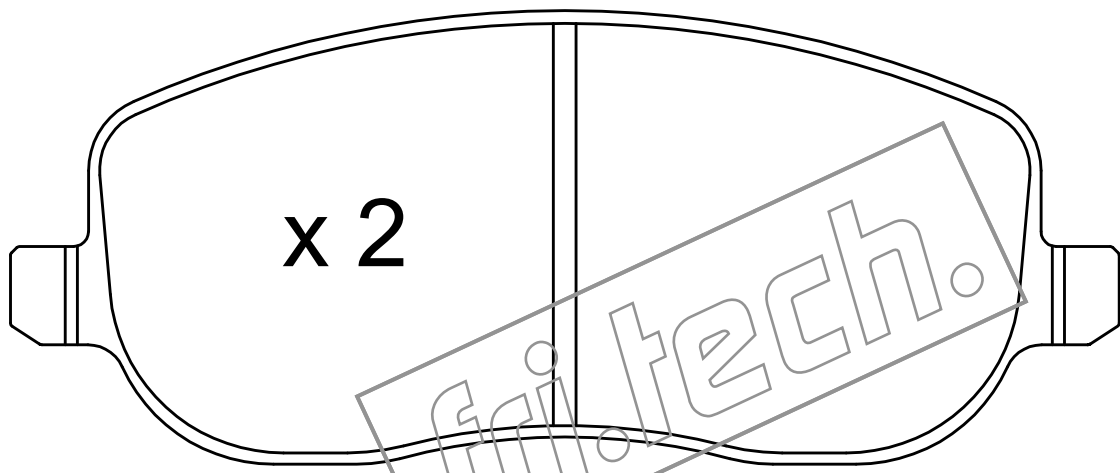

x 2

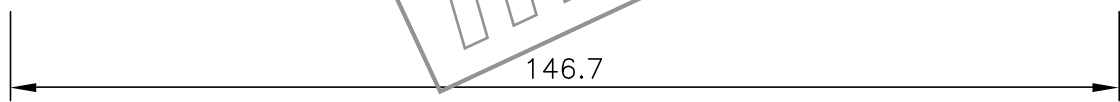

146.7

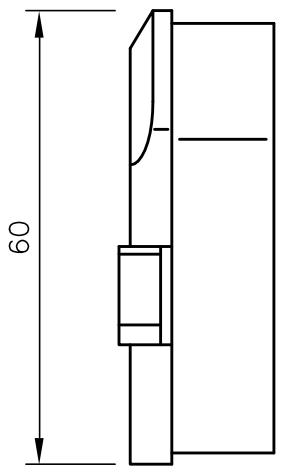
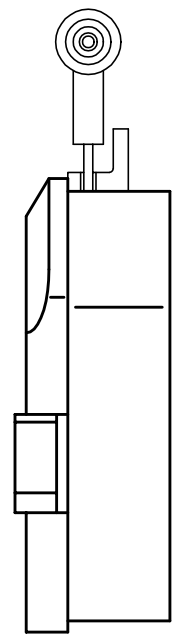

60

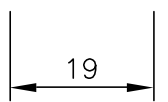

19

fri.tech.