

x 2

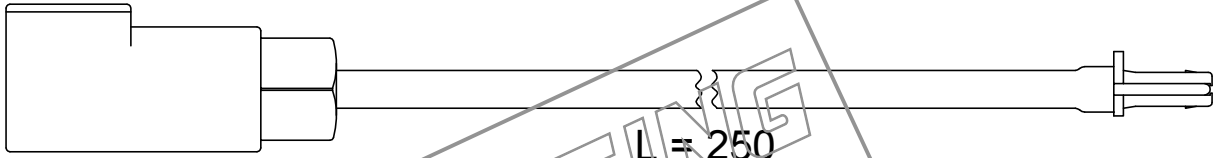

L = 250

x 4

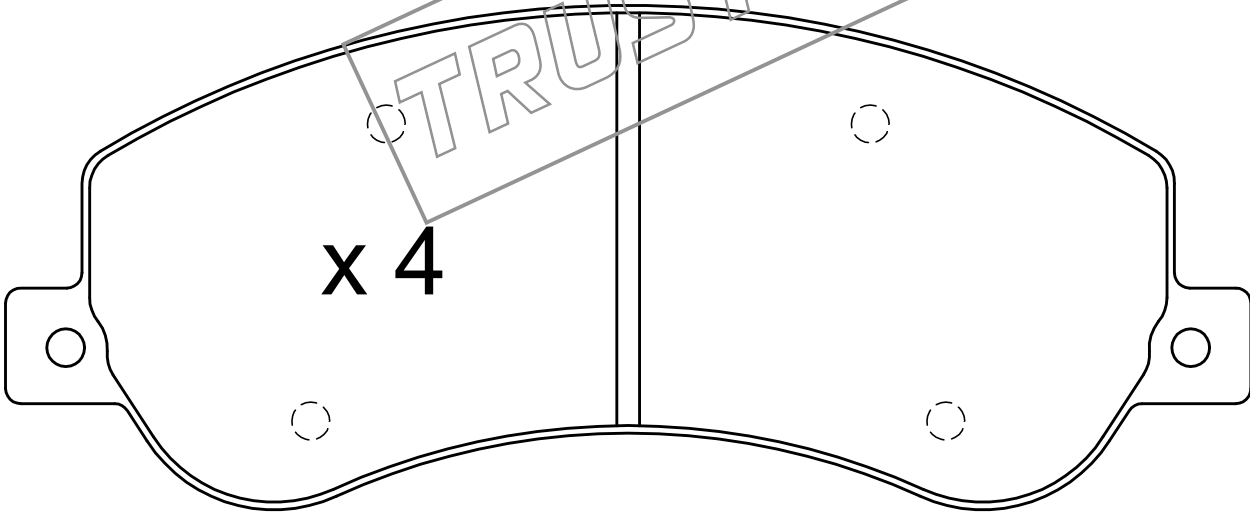

66.7

164.7

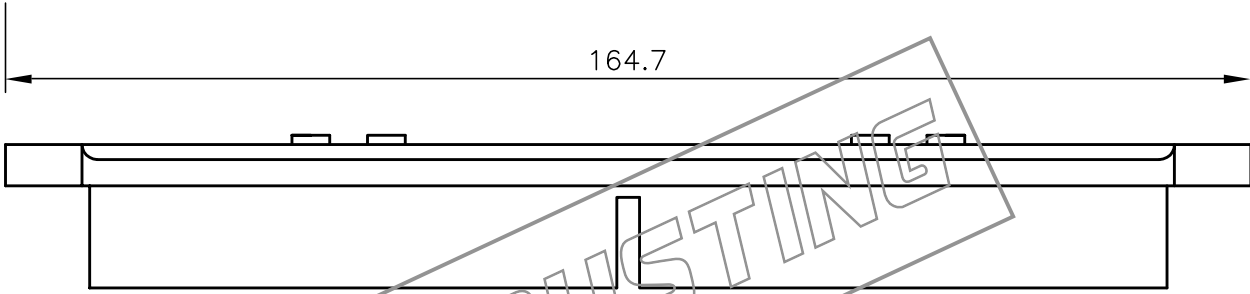

19

TRUSTING