

x 1

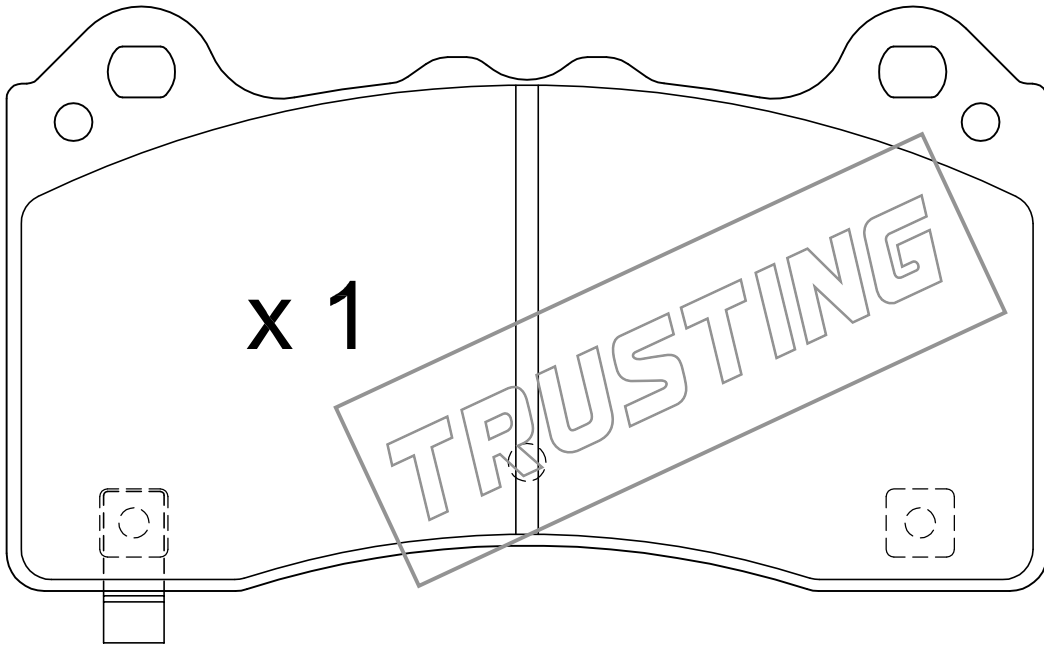

x 1

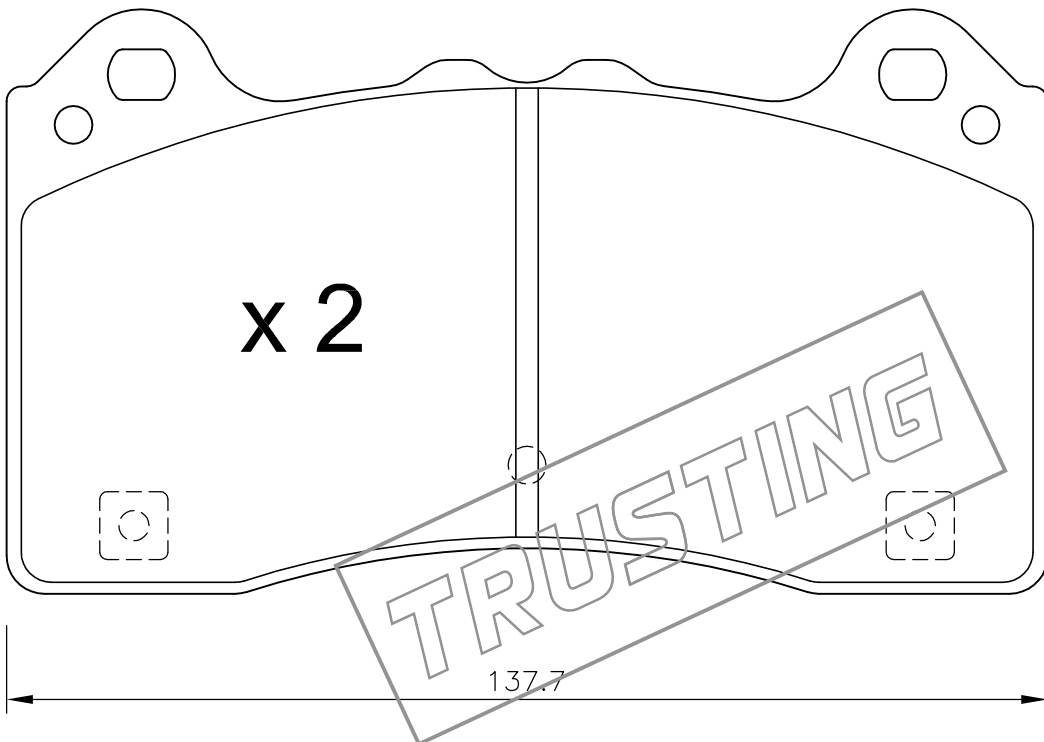

x 2

137.7

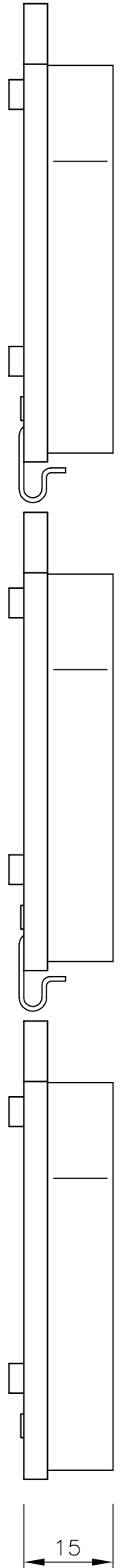

77.3

15