

x 2

L = 315

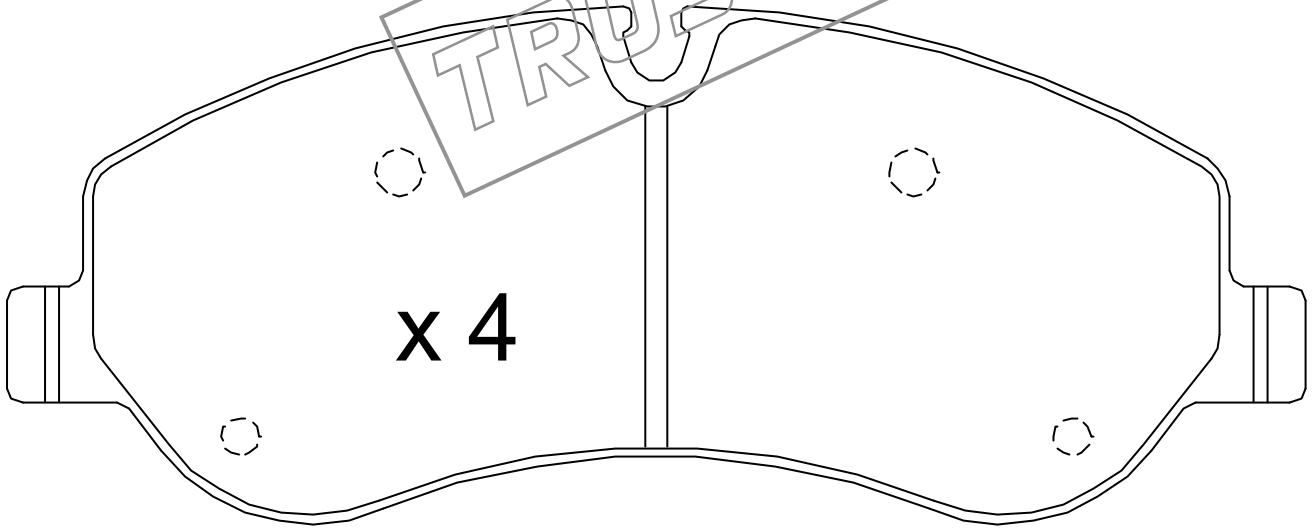
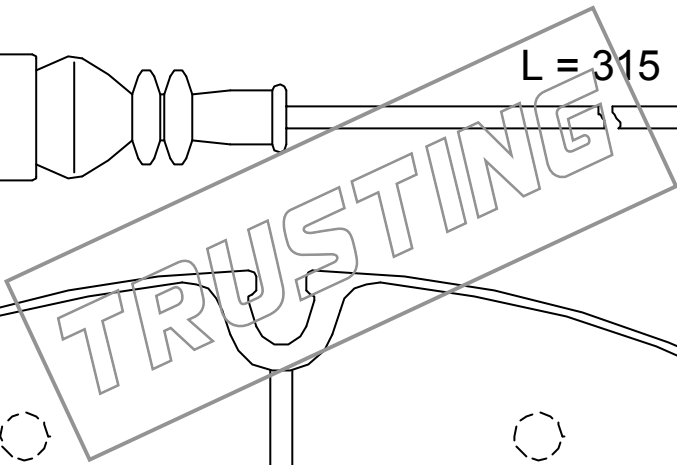

x 4

68.5

171.7

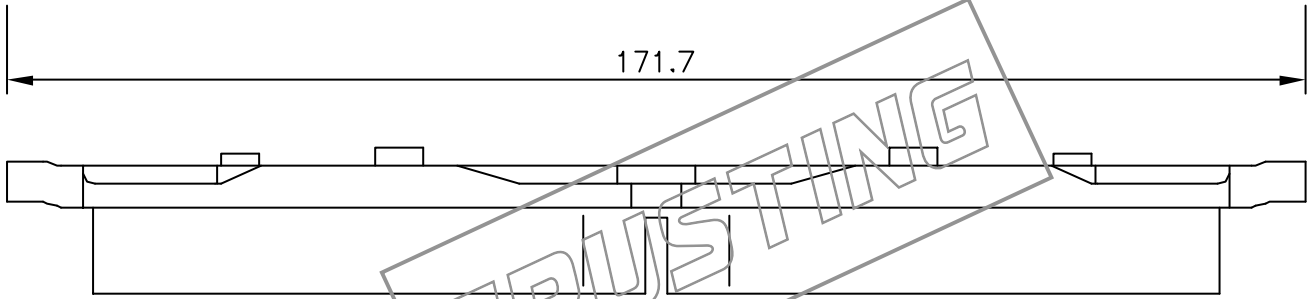

17

