

x 2 L = 140

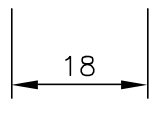
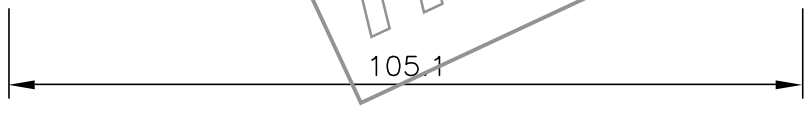
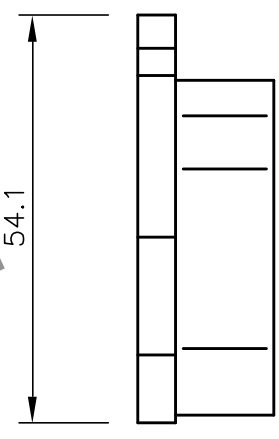
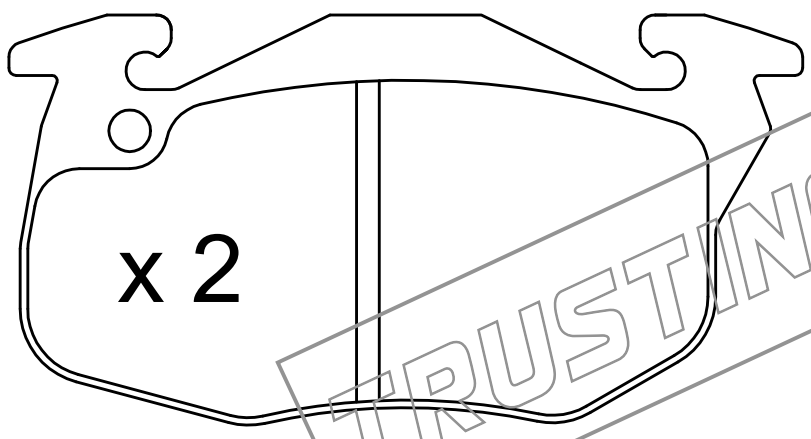
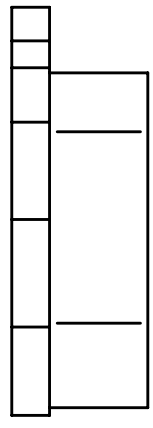
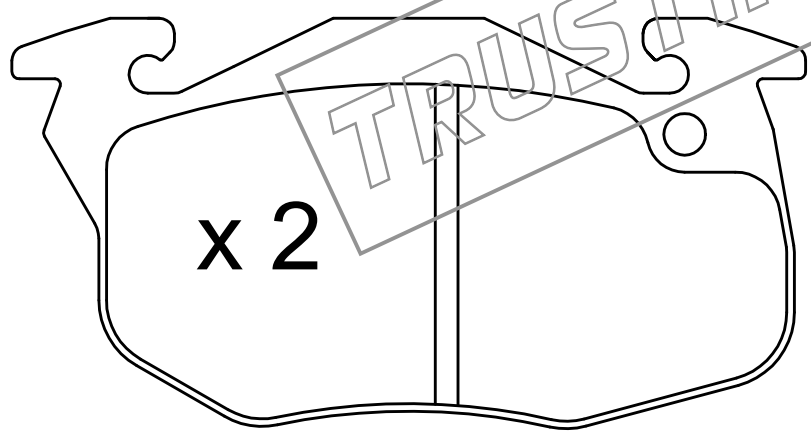

TRUSTING