

x 1

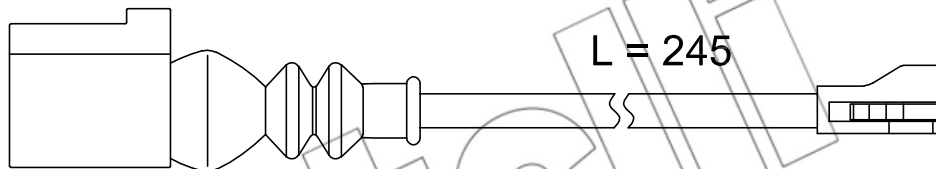

L = 245

x 4

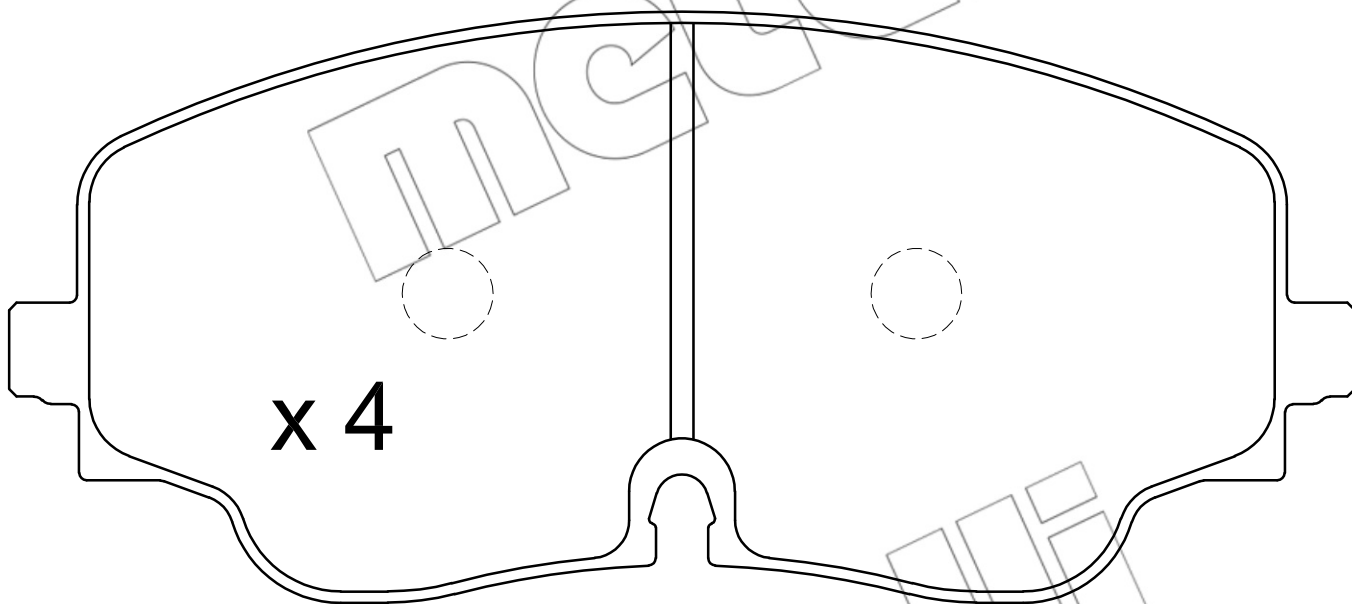

178

78.2

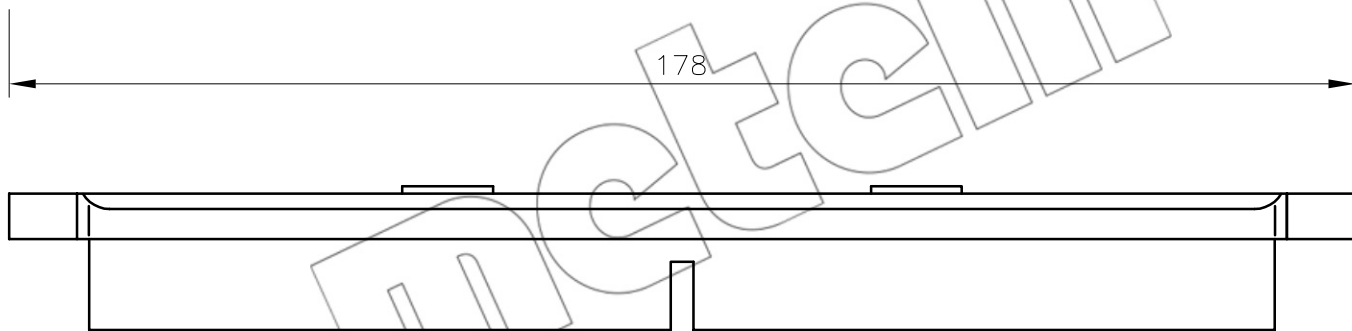

18

