

x 2

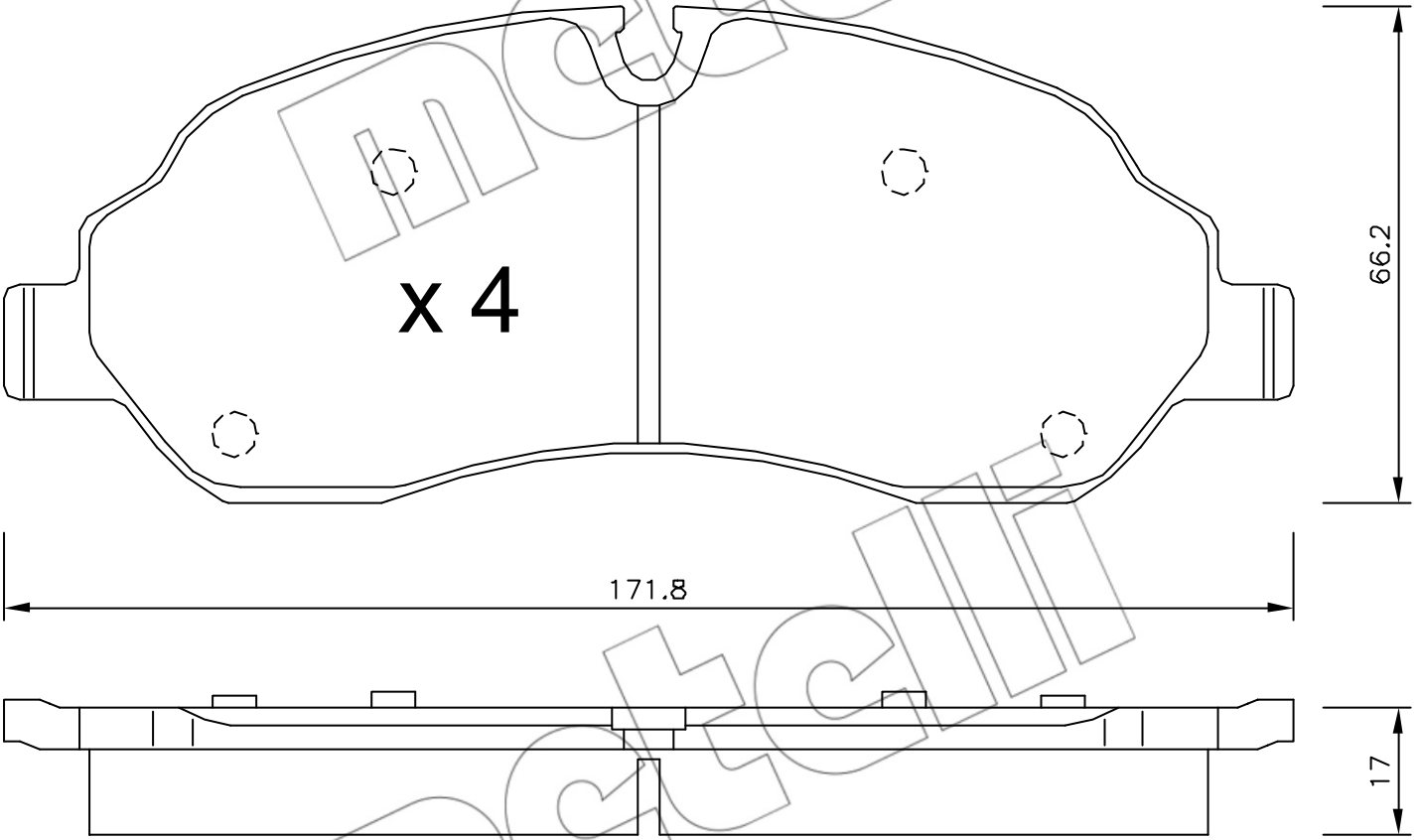

L = 315

x 4



171.8

66.2

17

metelli