

x 2

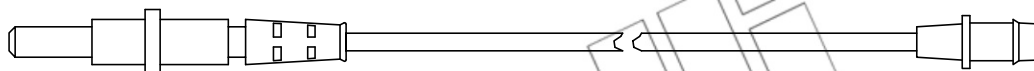

L = 280

x 4

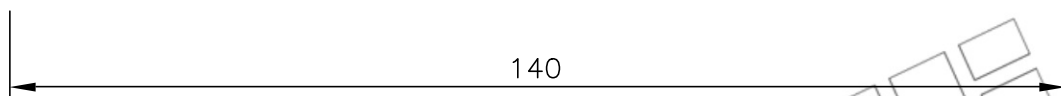
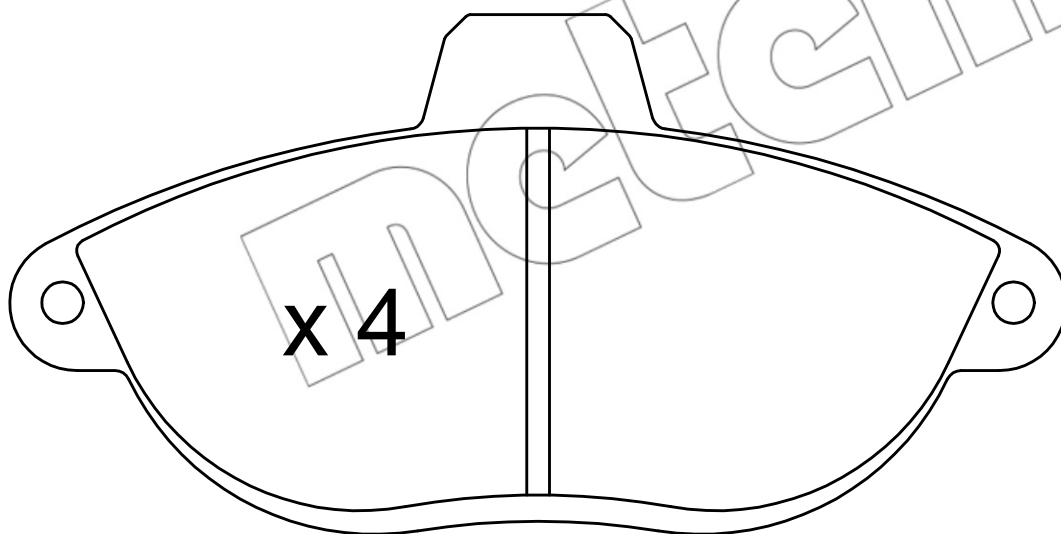

140

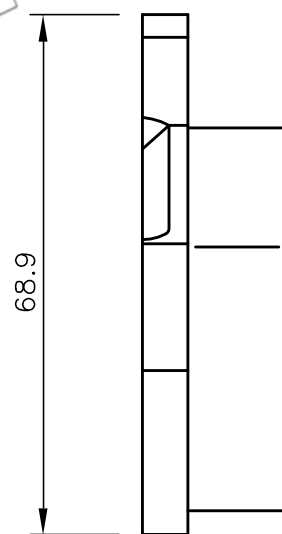

68.9

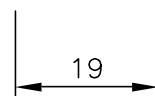

19

metelli