

**Einbauanleitung Elektrosatz
Anhängervorrichtung mit 13-P Steckdose
lt. DIN/ISO Norm 11446**

**Instructions de montage du faisceau
électrique pour crochet d'attelage
conforme à la norme
DIN/ISO 11446 prise 13-P**

**Fitting instructions electric wiringkit
towbar with 13-P socket up to
DIN/ISO norm 11446**

**Montage-handleiding elektrokabelset voor
trekhaak met 13-P contactdoos
vlg. DIN/ISO norm 11446**

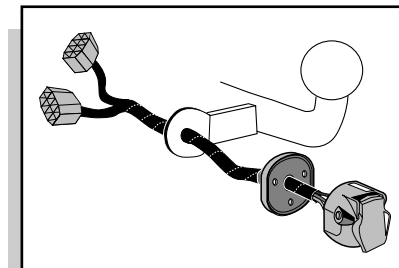

TOYOTA COROLLA SEDAN 2002-

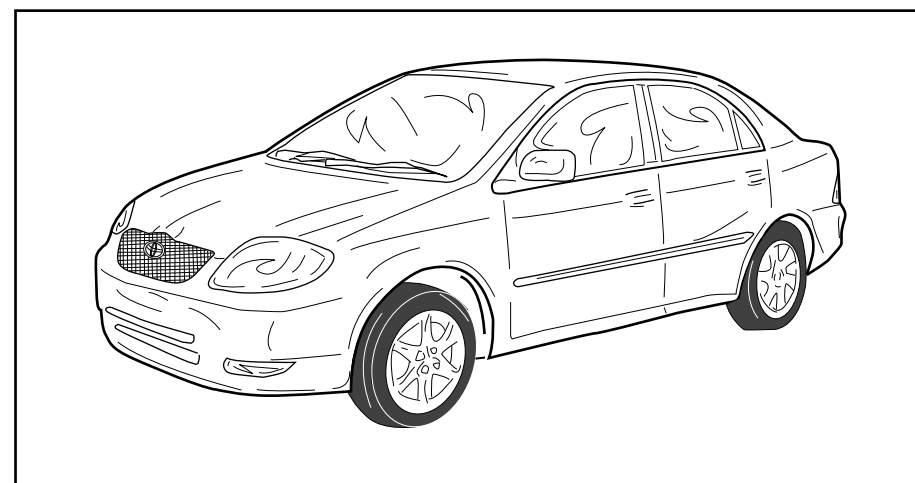

Bestel Nr.: TO-102-DL

* Teilliste

* Liste de pieces

* Part list

* Onderdelenlijst

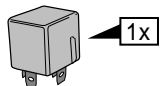
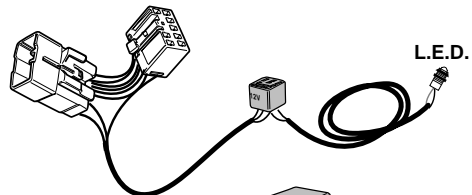
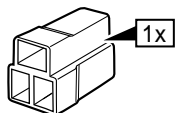
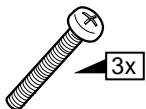
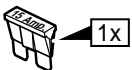
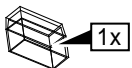
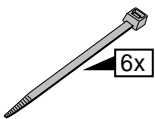
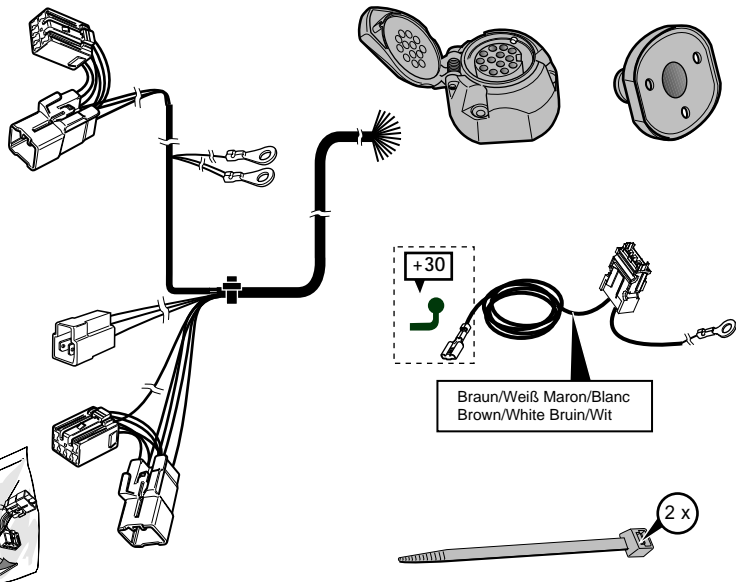
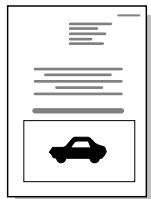
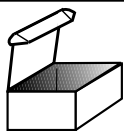

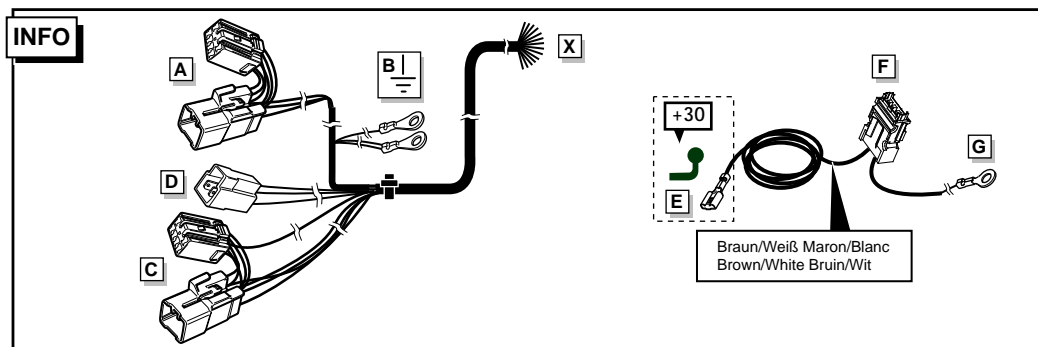
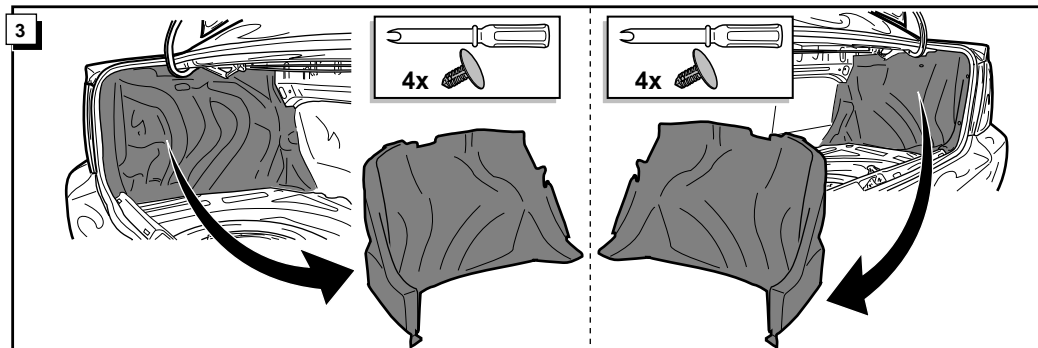
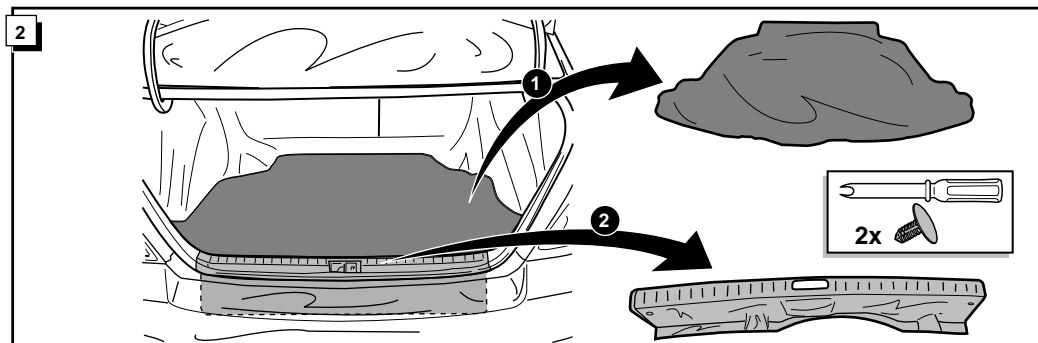
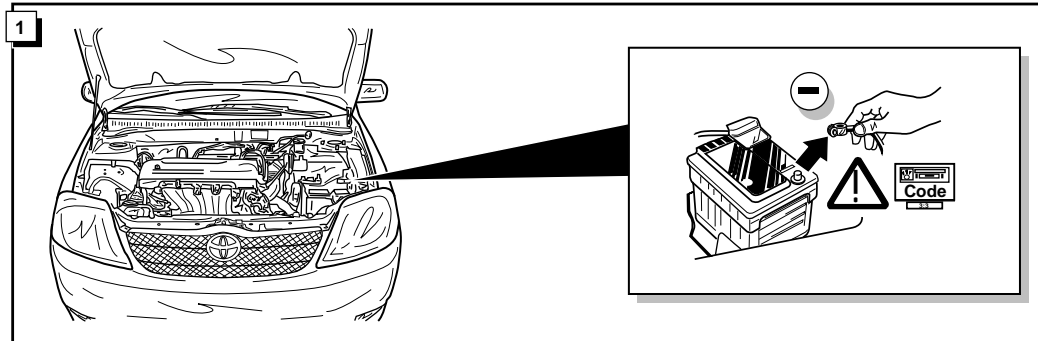

ROUTING

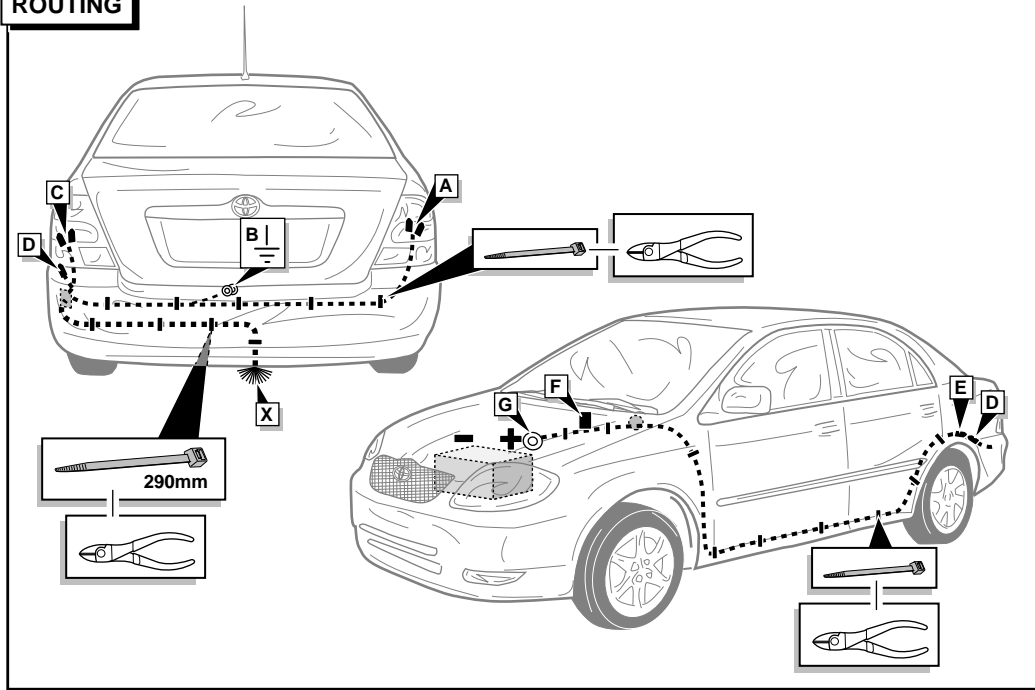

20

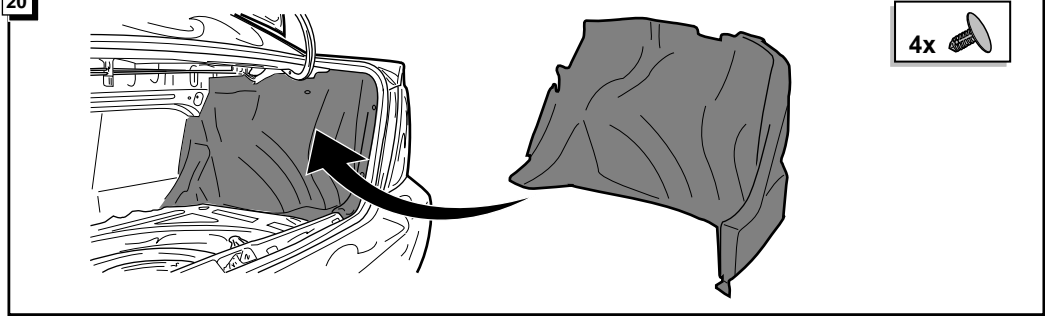

21

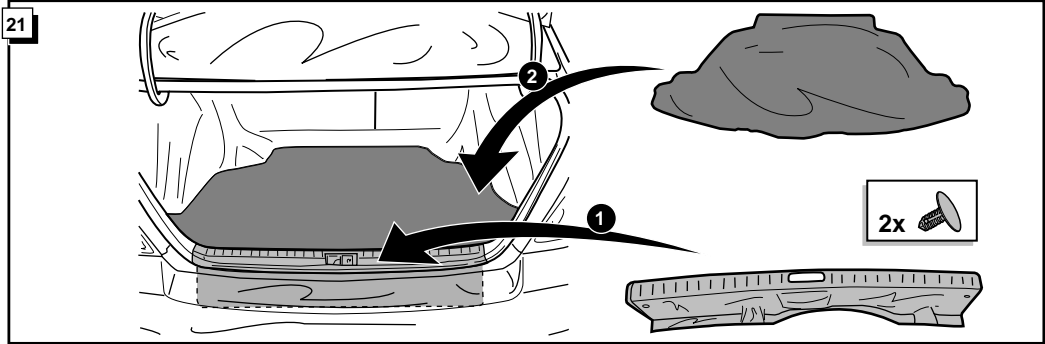

4

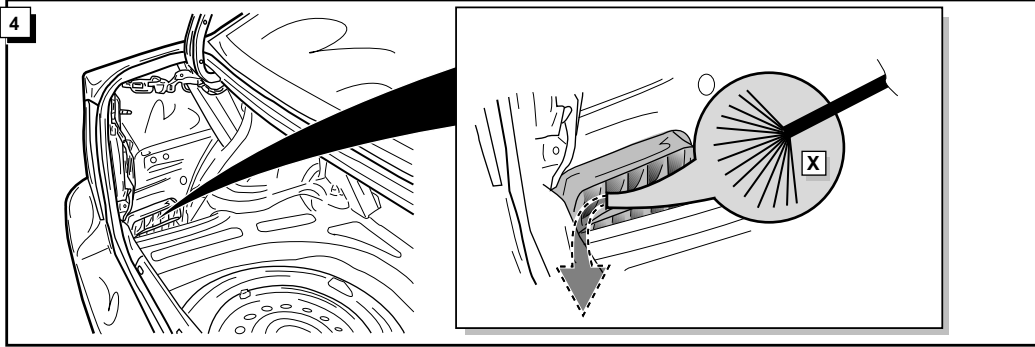

INFO

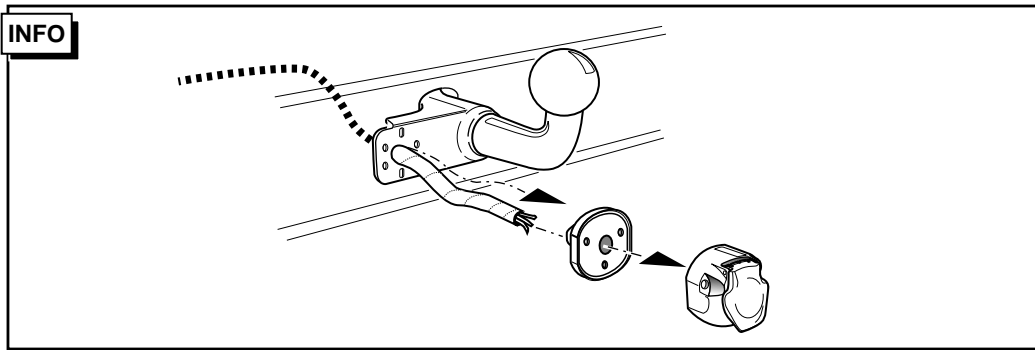

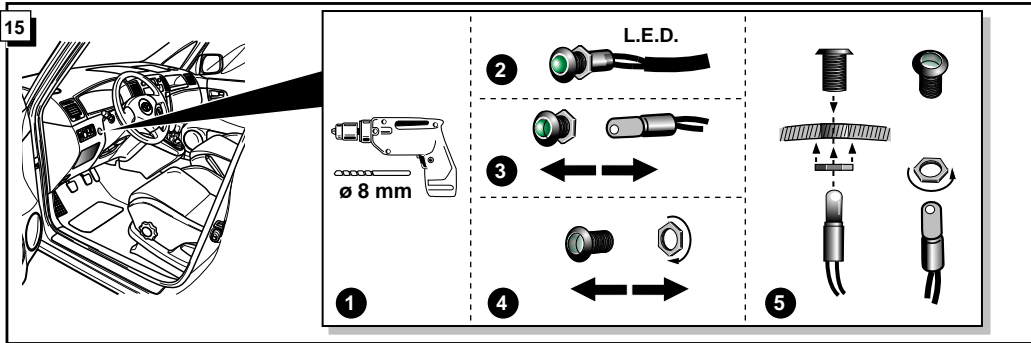

INFO Die Kontrolleuchte blinkt, wenn beim angeschlossenen Anhänger die Blinker (3x21W) oder Warnblinkanlage (6x21W) eingeschaltet sind.

Le deuxième témoin de contrôle clignote lorsque les feux de détresses (6X21W) et les clignotants (3X21W) du véhicule sont allumés alors que la caravane/remorque est accouplée au véhicule.

By switching on flashers with the trailer connected (3x21W) or the warning lights (6x21W), the 2nd direction indicator light will flash.

Het controle-lampje knippert wanneer bij aangesloten aanhanger de knipperlichten (3x21W) of waarschuwingslichten (6x21W) ingeschakeld zijn.

5 Anschluß Steckdose / Connection de la prise / Socket connection / Contactdoos aansluiting

DIN/ISO 11446	(D)	(F)	(GB)	(NL)	
←	1/L	gelb	jaune	yellow	geel
→	2	blau	bleu	blue	blauw
↔	2a	grau	gris	grey	grijs
⊖	1-8	weiß	blanc	white	wit
↗	4/R	grün	vert	green	groen
☀	5/58-R	braun	marron	brown	bruin
STOP	6/54	rot	rouge	red	rood
☀	7/58-L	schwarz	noir	black	zwart
↔	8	schwarz/rot	noir/rouge	black/red	zwart/rood
15 amp. 30+	9	braun/weiß	marron/blanc	brown/white	bruin/wit
15 amp. 15+	10	rot	rouge	red	rood
⊖	10	weiß	blanc	white	wit
↔	12	rot/blau	rouge/bleu	red/blue	rood/blauw
⊖	9	weiß	blanc	white	wit

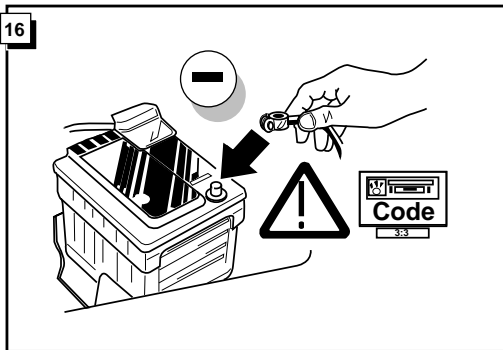

17

! FUNKTIONEN KONTROLLIEREN !
! CONTRÔLER LES FONCTIONS !
! CHECK FUNCTIONS !
! CONTROLEER FUNCTIES !

