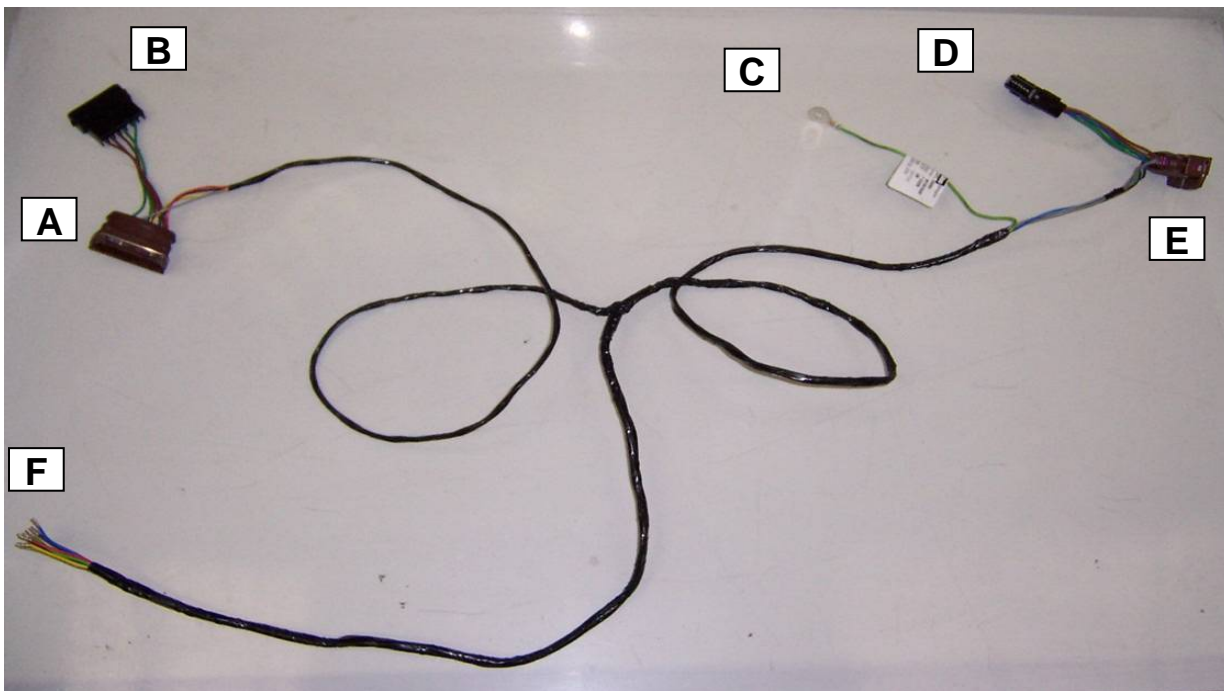
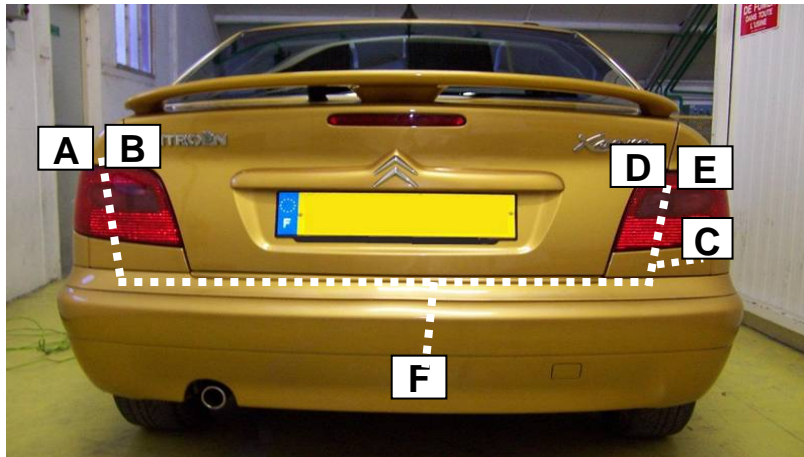
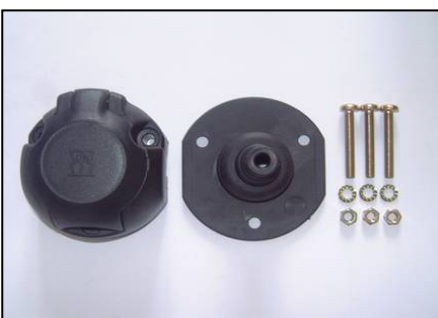

**Citroën Xsara**

Einbauanleitung electrosatz Anhängervorrichtung mit 12N Steckdose  
Fitting instructions electric wiringkit towbar with 12N socket  
Montage-handleiding elektrokabelset voor trekhaak met 12N contactos

**Liste des pièces / Teilliste / Part list / Onderdelenlijst :**

J x 10

K x 2

Cette notice ne peut être divulguée ou reproduite, partiellement ou en totalité, sans accord de la société.

1

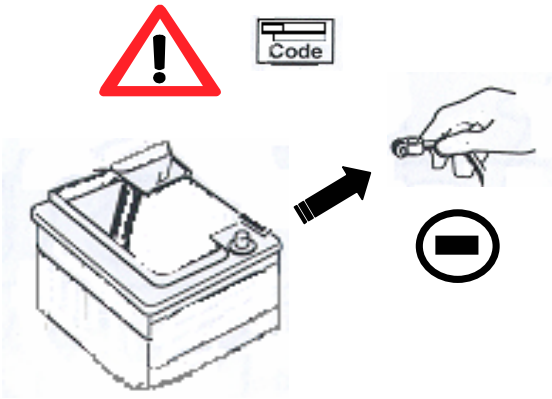

2

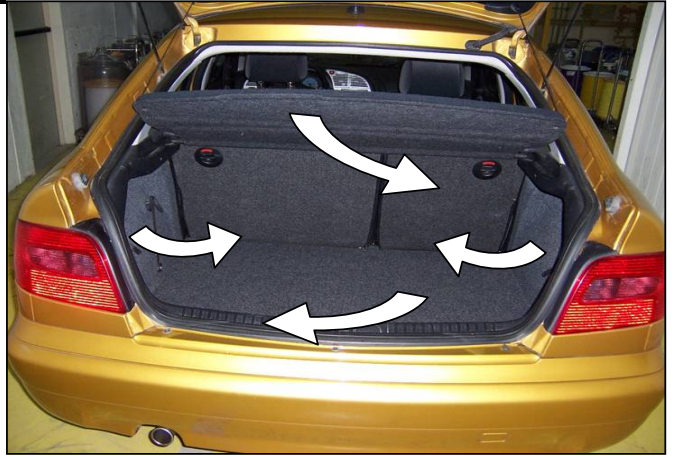

3

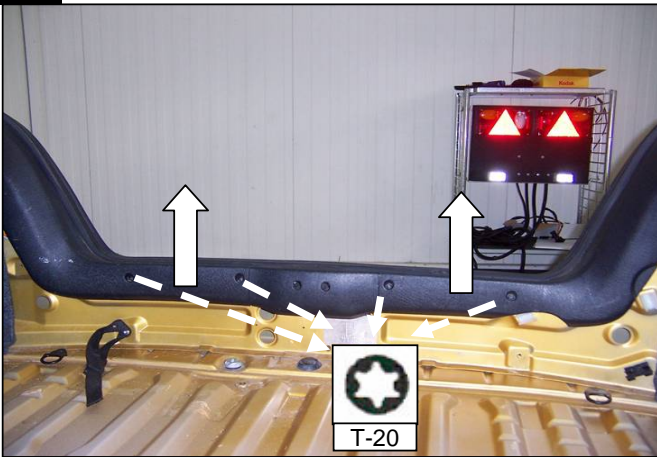

4

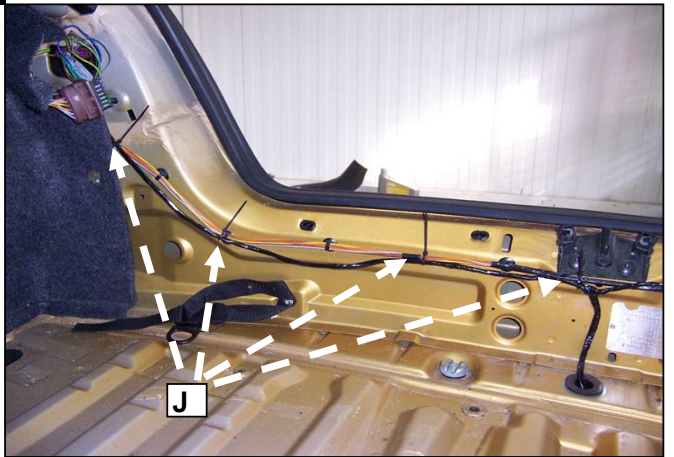

5

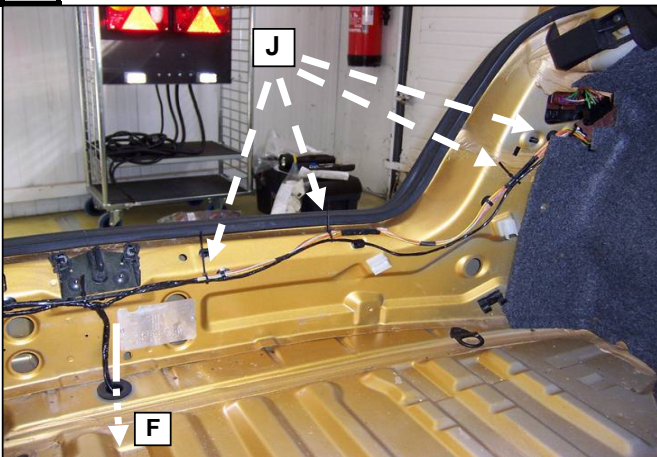

6

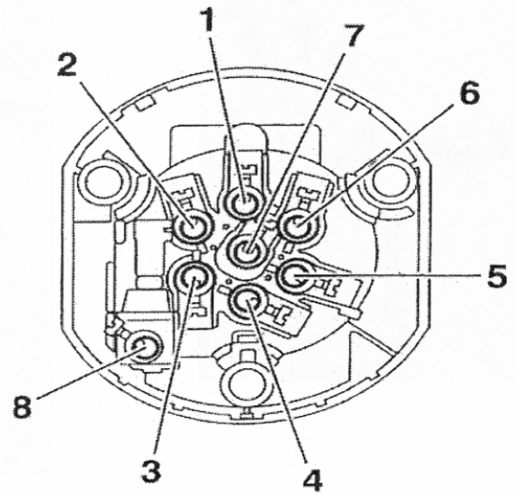

	<b>1/L</b>	<b>2/54g</b>	<b>3/31</b>	<b>4/R</b>	<b>5/58R</b>	<b>6/54</b>	<b>7/58L</b>	<i>8/58B</i>
	21+5 W	21W		21+5 W	40 W	63 W	40 W	
<b>F</b>	Jaune	Bleu	Vert/jaune	Vert	Marron	Rouge	Noir	Gris
<b>D</b>	Gelb	Blau	Grün/gelb	Grün	Braun	Rot	Schwarz	Grau
<b>GB</b>	Yellow	Blue	Green/yellow	Green	Brown	Red	Black	Grey
<b>NL</b>	Geel	Blauw	Groen/geel	Groen	Bruin	Rood	Zwart	Grijs
<b>P</b>	Amarelo	Azul	Verde/amarelo	Verde	Castanho	Vermelho	Preto	Cinzeno
<b>I</b>	Giallo	Blu	Verde/giallo	Verde	Marrone	Rosso	Nero	Grigio
<b>E</b>	Amarillo	Azul	Verde/amarillo	Verde	Marron	Rojo	Negro	Gris

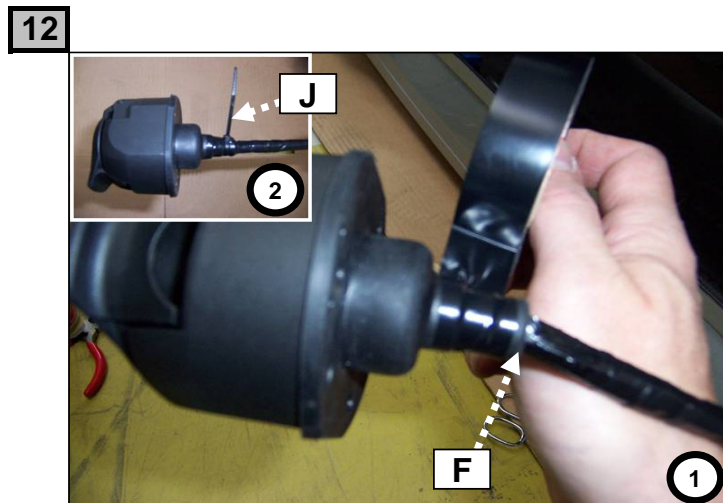
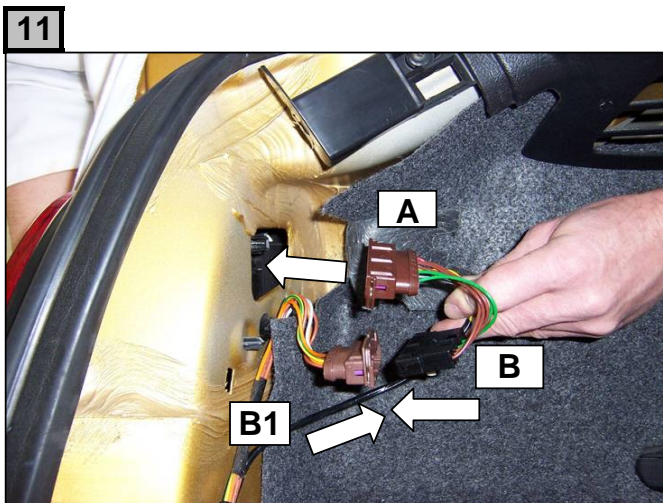
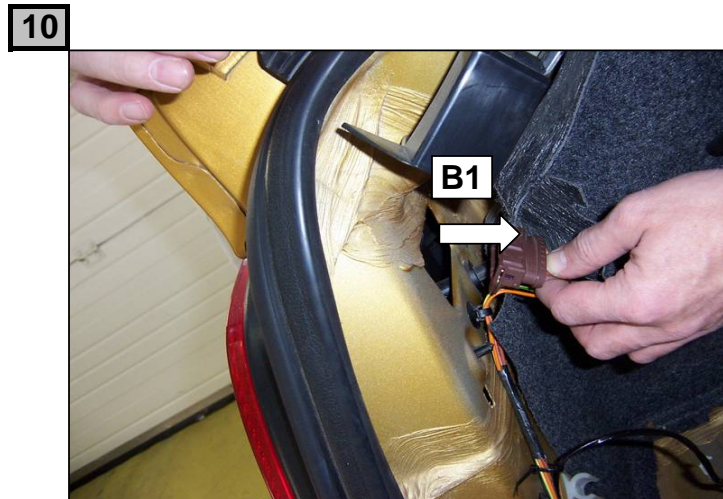
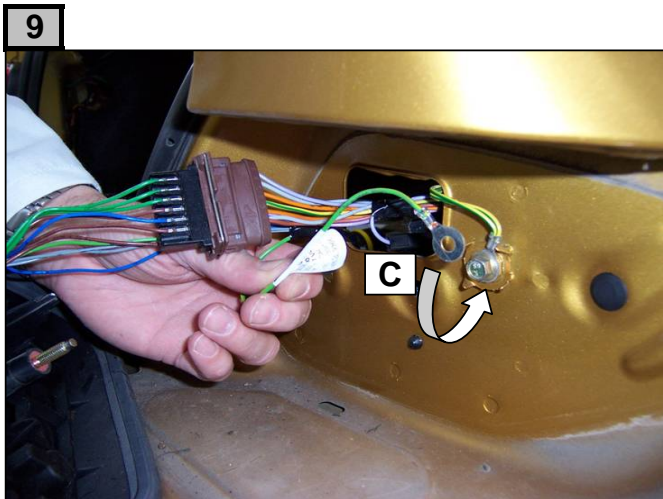
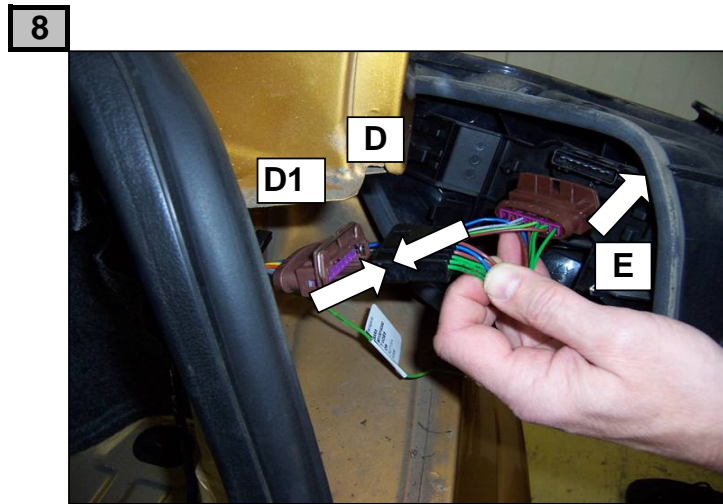
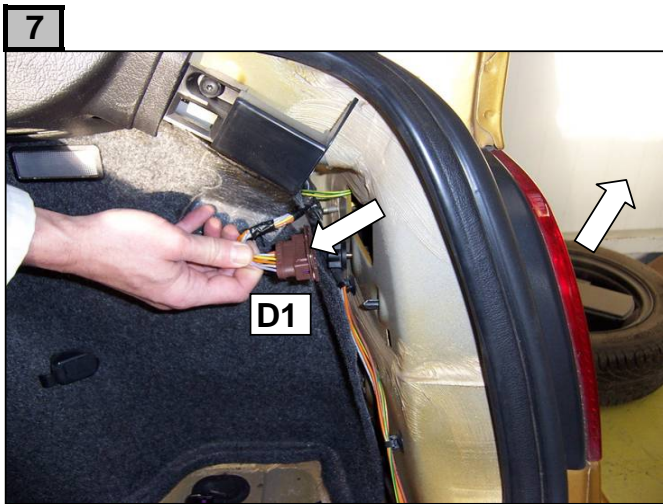

**13**

**Contrôler les fonctions**  
**Funktionen kontrollieren**  
**Check functions**  
**Controleer functies**

**OK**

**14**

**OK**