

Fitting instructions

Make: Citroën

C5

Type: 4821

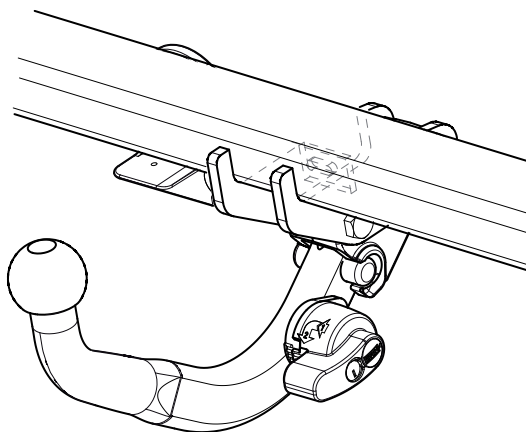







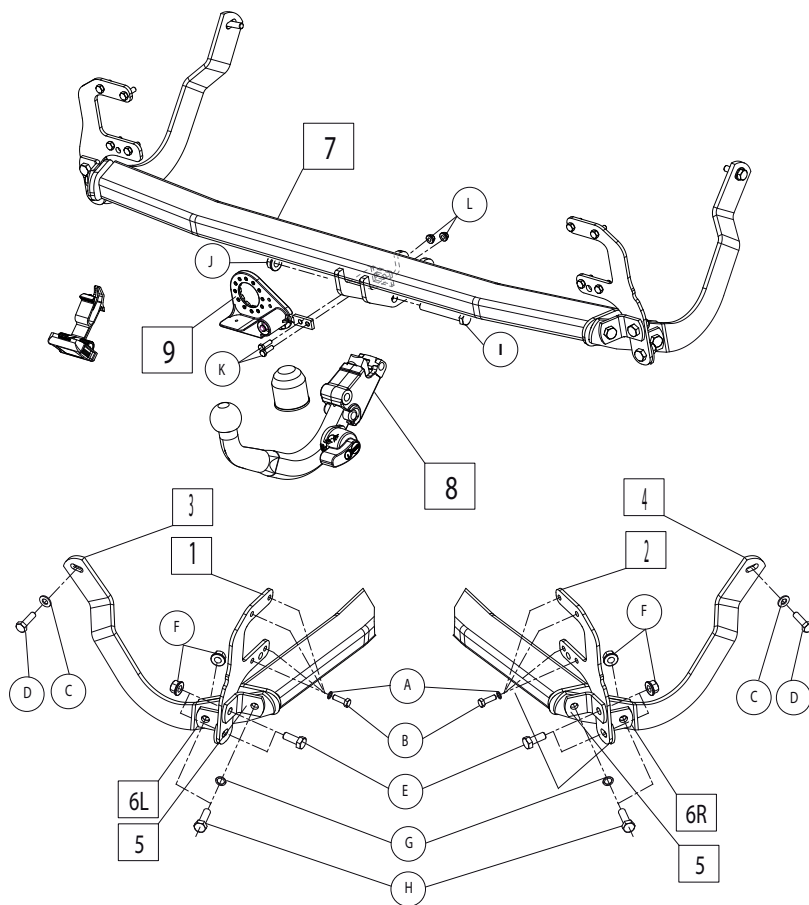

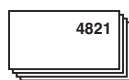
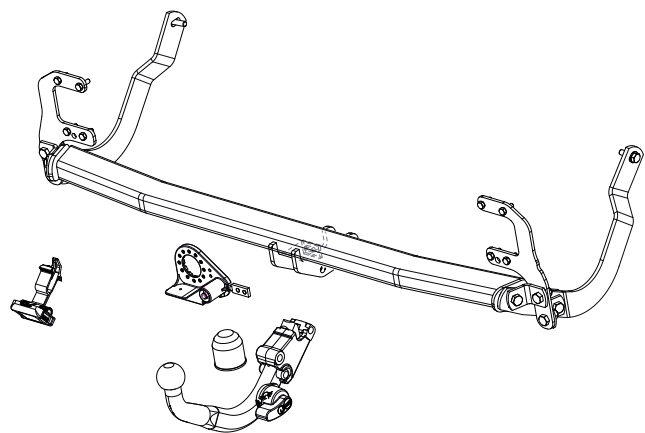
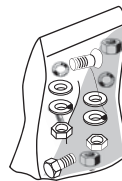
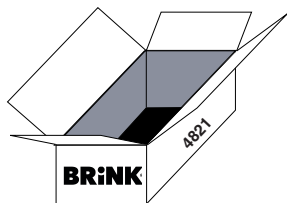



- NL Montagehandleiding
- GB Fitting instructions
- D Montageanleitung
- F Instructions de montage
- S Monteringsanvisningar
- DK Montagevejledning
- E Instrucciones de montaje
- I Istruzioni per il montaggio
- PL Instrukcja montażu
- SF Asennusohjeet
- CZ Pokyny k montáži
- H Szerelési útmutató
- RUS Руководство для монтажа

BRiNK[®]

Your perfect fit
brink.eu

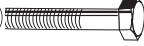



- A  x8 HM8
- B  x8 M8 Schnor
- C  x2 M10
- D  x2 HM10X35
- E  x4 Hm12x30
- F  x6 HM12
- G  x2 M12 Schnor
- H  x4 HM12x40
- I  x2 HM12x90 (10.9)
- J  x2 HM12 (10)
- K  x2 HM6x20 (8.8)
- L  x2 HM6 (8)

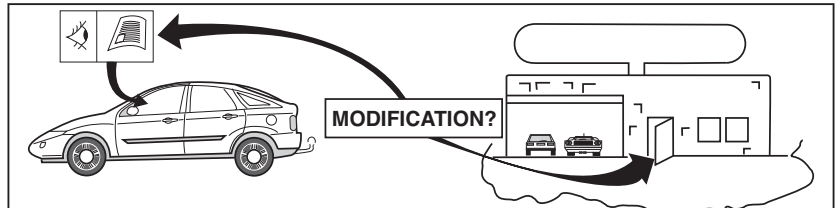
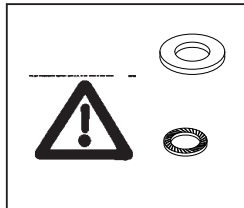
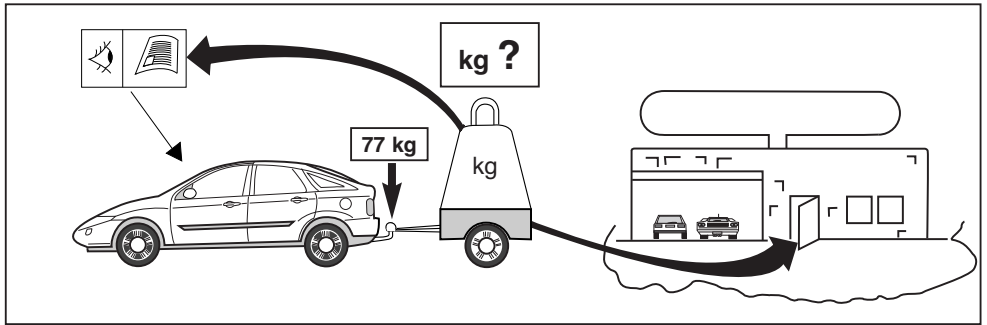
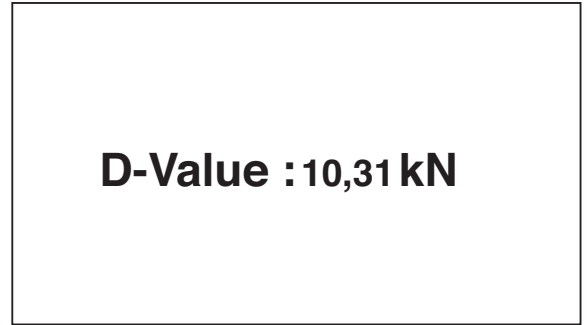
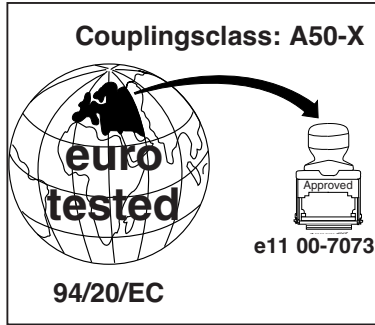
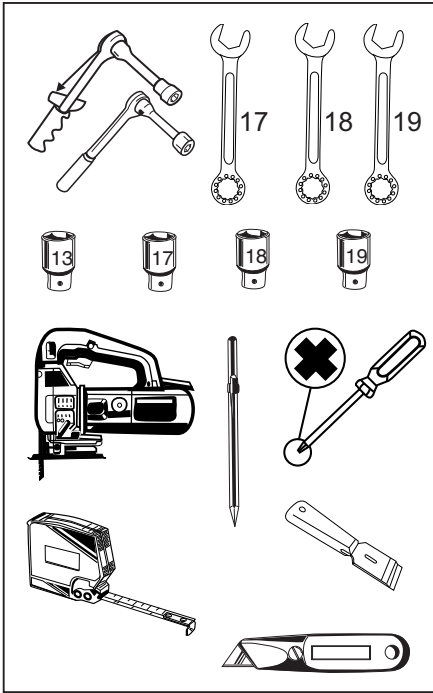



NOTE:

* Should this installation process entail the cutting of the bumper – conformation **MUST** be obtained by the installation engineer of the customer's acceptance prior to completion. 6 f]b_ Towing Systems do not accept responsibility for any matters arising as a result of this miscommunication.

All measurements are in mm!

HINWEISE:

* Die für das Fahrzeug zugelassene Anhängelast ist den Fahrzeug Unterlagen zu entnehmen. Bei Änderungen des Fahrzeuggewichtes muß die höchstzulässige Anhängelast gegebenenfalls aus dem D-Wert nachgerechnet werden.

Auskunft hierüber kann Ihr Fachhändler oder der TÜV geben.

* Elektrische Anlage gemäß StVZO anbringen.

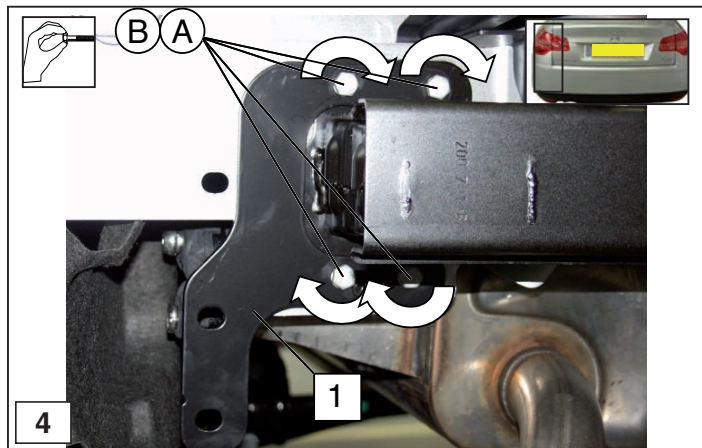
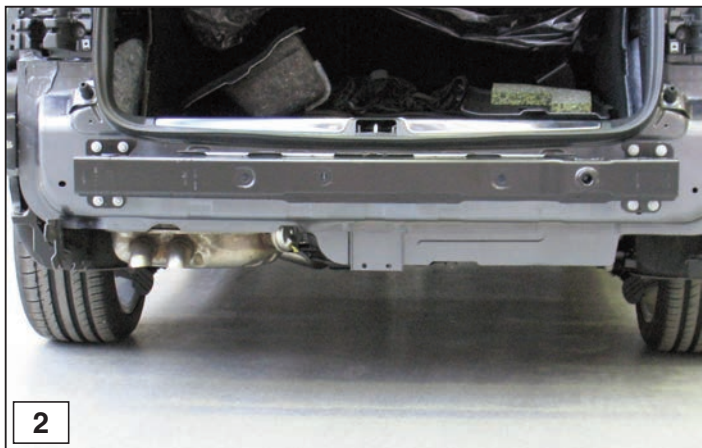
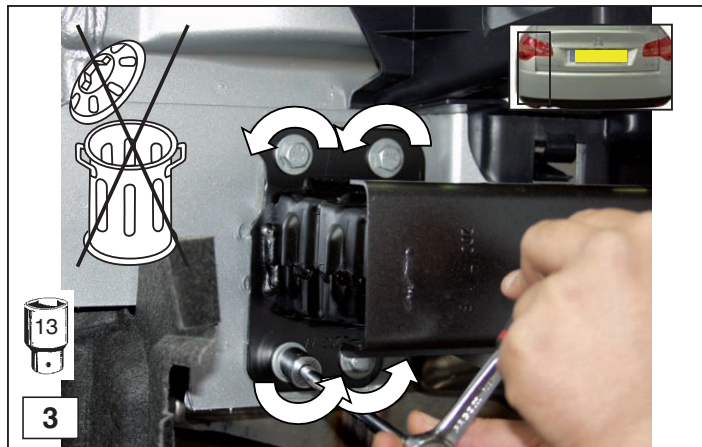

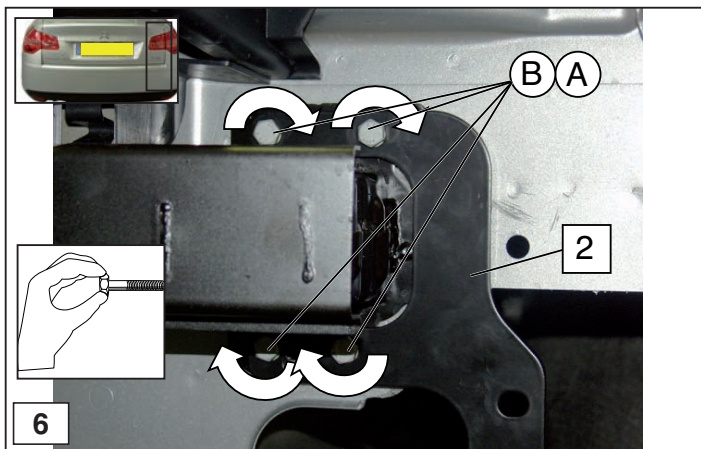
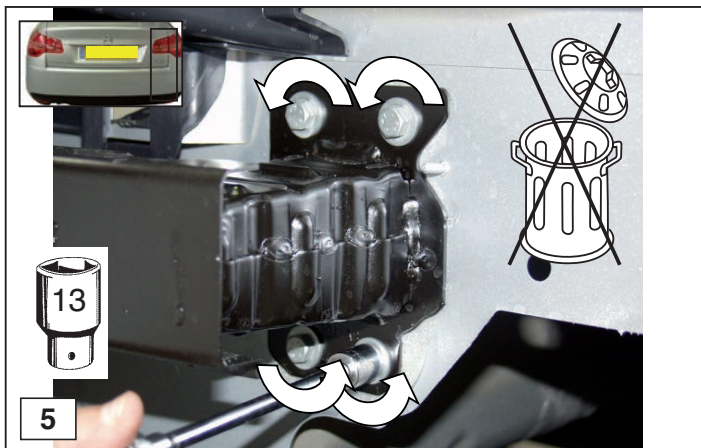

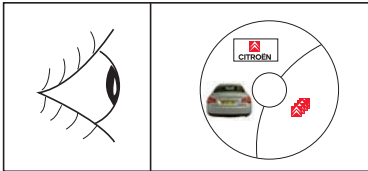
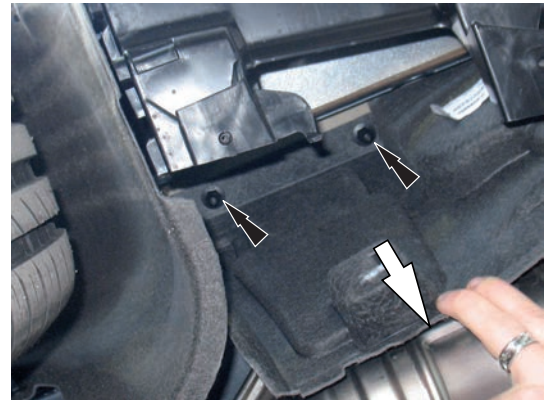
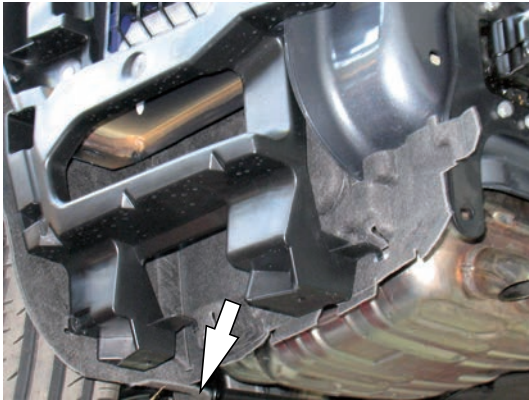

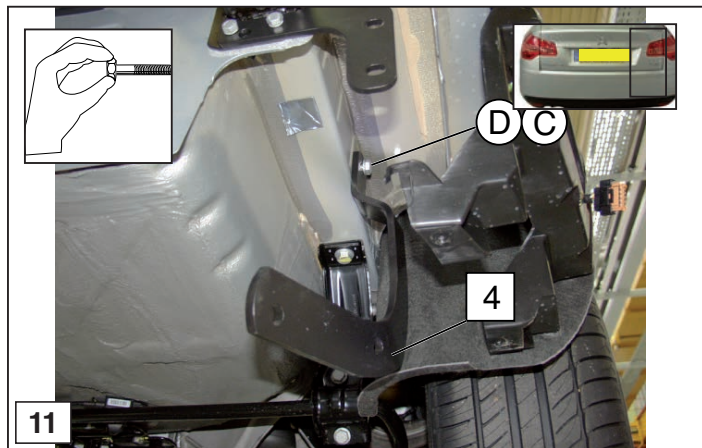
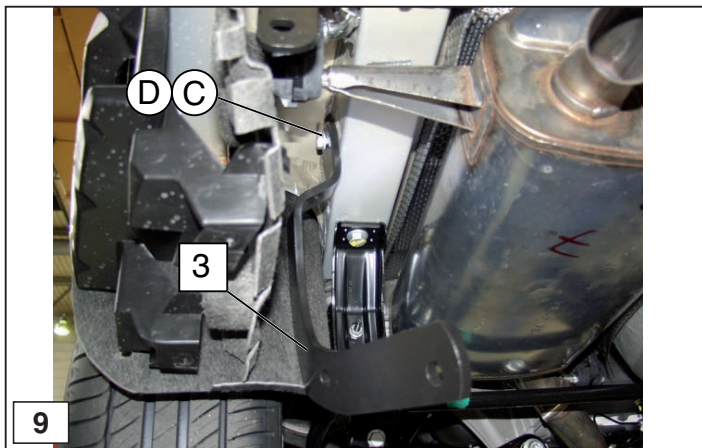
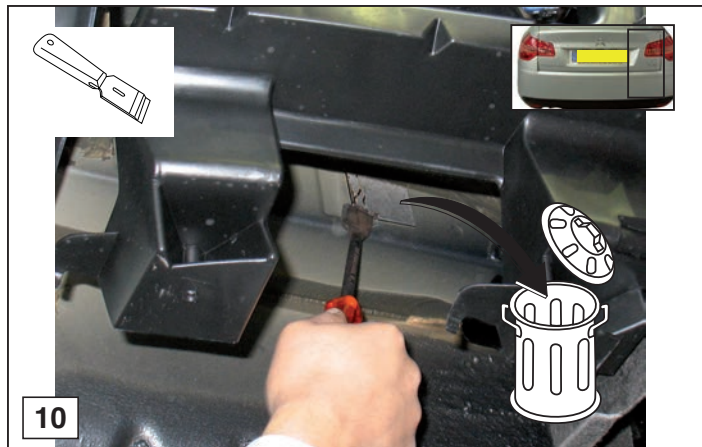

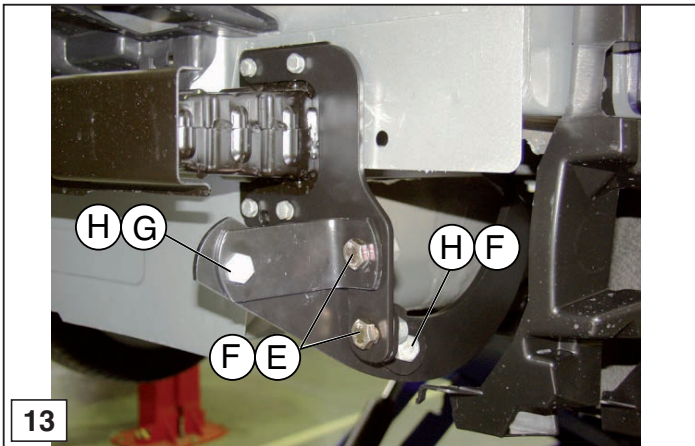
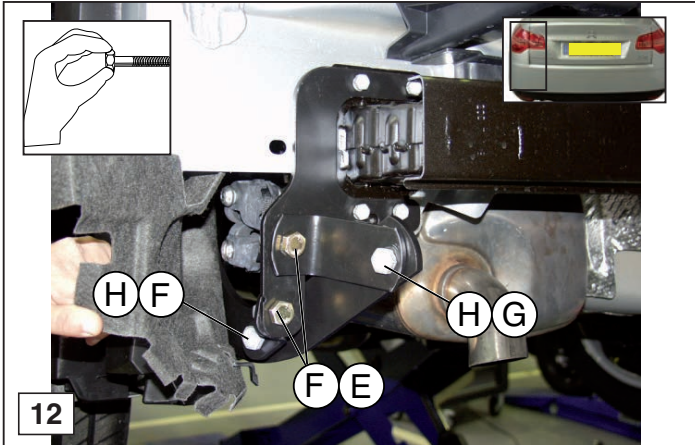

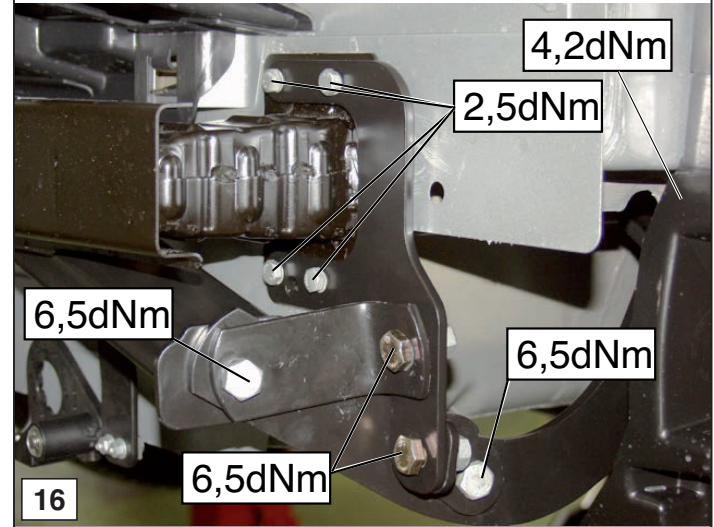
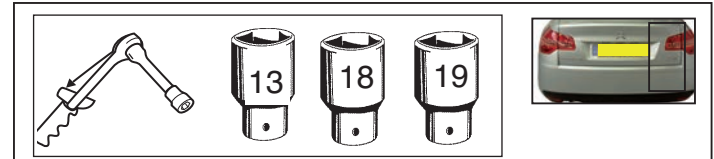
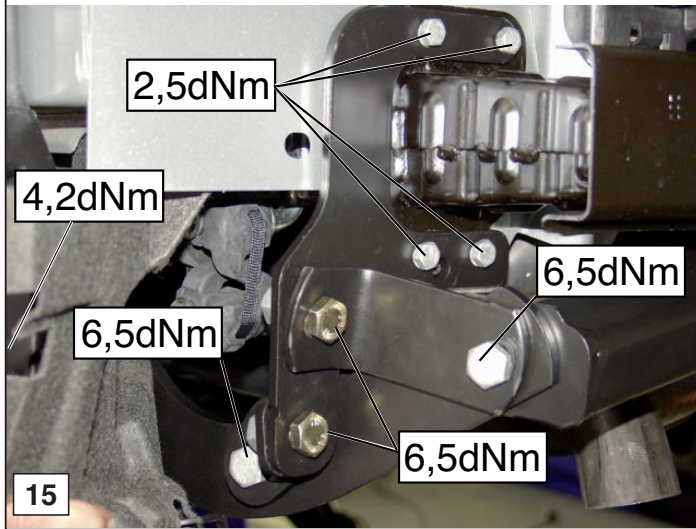
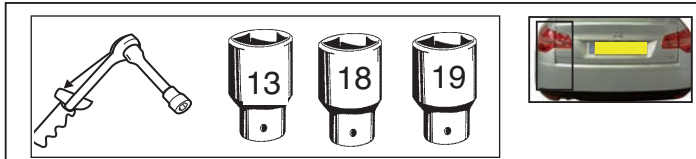

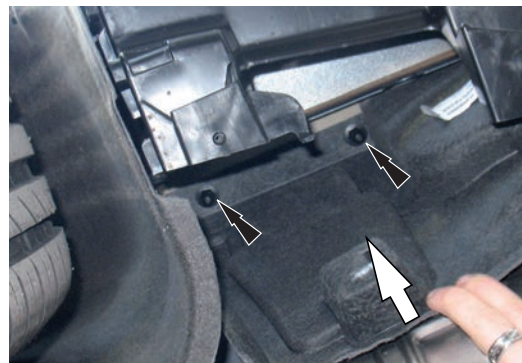
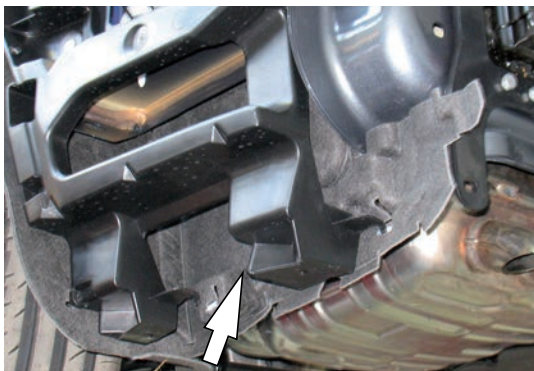
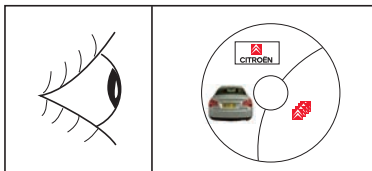

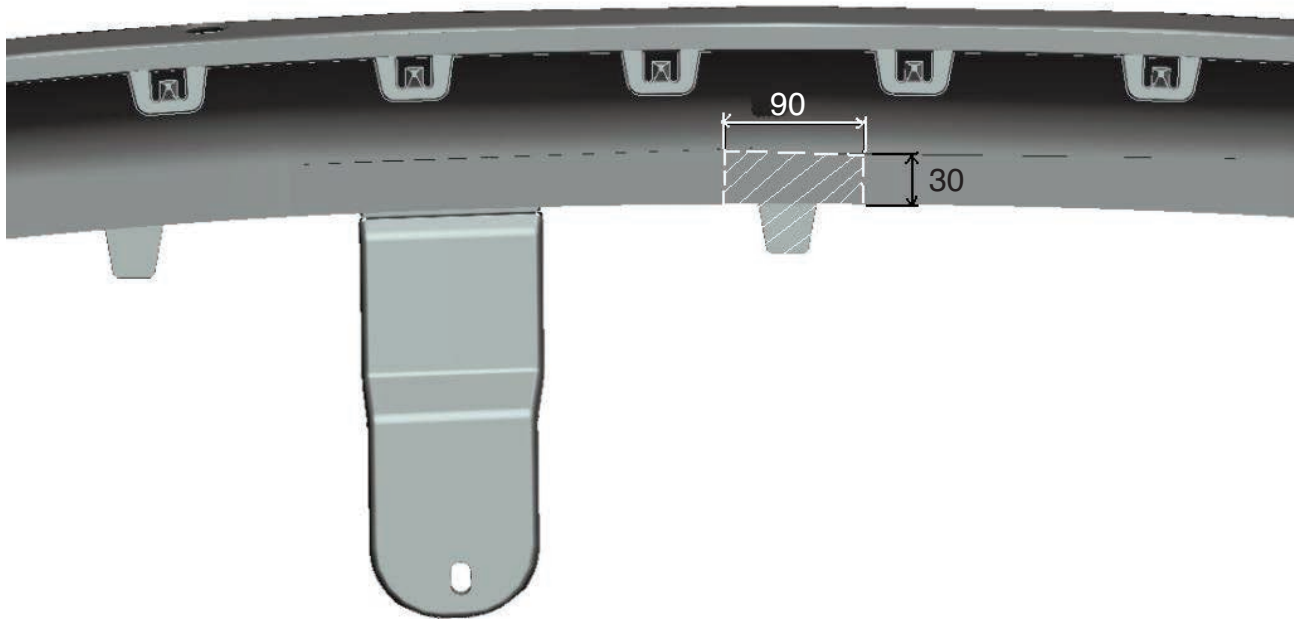
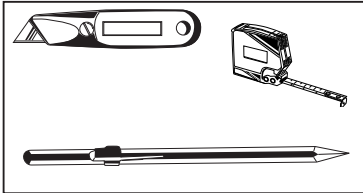



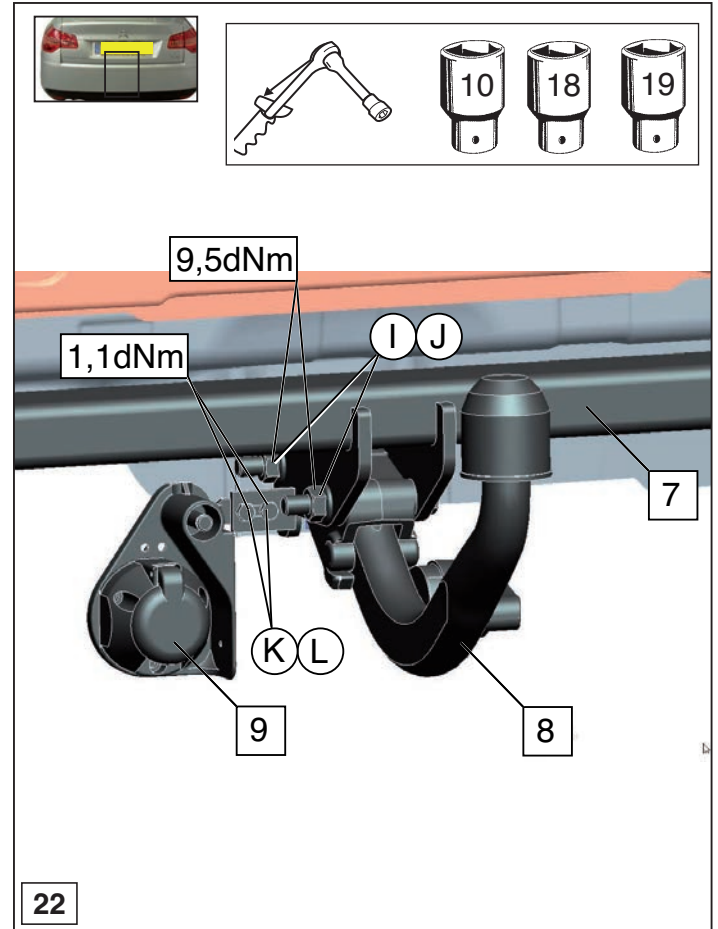



Dispositivo di traino tipo: 4821
Per autoveicoli: Citroën C5
Tipo funzionale: RW****
Classe e tipo di attacco: A50-X
Omologazione: e11 00-7073
Valore D: 10,31 kN
Carico Verticale max. S: 77 kg kg

Larghezza rimorchiabile per Caravan e T.A.T.S.: 2,55m vedere CARTA di CIRCOLAZIONE VEICOLO (motrice) + 70 cm = ..arrotondare ai 5 cm superiore (vedi D.M.28/05/85)

Massa rimorchiabile: vedi carta di circolazione dell' autoveicolo

Per verificare l' idoneità del dispositivo di traino omologato a norma CEE 94/20, all' installazione sulla vettura su cui si intende procedere al montaggio, compilare la seguente formula (se necessario declassare la massa rimorchiabile):

$$D = \frac{T \times C}{T + C} \times 0,00981 \leq 10,31 \text{ kN}$$

dove: T= Massa Complessiva Max. della motrice (in kg)
C= Massa Rimorchiabile Max. della motrice (in kg)

DA COMPILARE PER IL COLLAUDO

DICHIARAZIONE DI CORRETTO MONTAGGIO: la sottoscritta Ditta dichiara di aver montato in maniera corretta ed in conformità/ alle prescrizioni sia del costruttore del veicolo che del costruttore del dispositivo stesso il seguente dispositivo di attacco meccanico:

tipo:.....
Il dispositivo di attacco sopra indicato è stato installato su autoveicolo
modello:.....
targa:.....
Data:.....

TIMBRO e FIRMA

Si dichiara inoltre di aver informato l'utente del veicolo sull'USO e MANUTENZIONE del dispositivo stesso.