

- D** Elektroanlage für Anhängervorrichtung Montage- und Betriebsanleitung, Originalbetriebsanleitung
- CZ** Elektrické zařizení pro tažné zařizení Montážní a provozní návod
- DK** Elsæt til anhængertræk Montage- og driftsvejledning
- E** Instalación eléctrica para el dispositivo de remolque Instrucciones de montaje y de servicio
- F** Installation électrique pour dispositif d'attelage Notice de montage et d'utilisation
- FIN** Vetolaitteen sähköjärjestelmä Asennus- ja käyttöohjeet
- GB** Electrical system for trailer hitch Installation and Operating Instructions
- GR** Ηλεκτρικό σύστημα για διάταξη ρυμούλκησης Οδηγίες συναρμολόγησης και λειτουργίας
- H** Elektromos felszerelés a vonószerkezet Beszerelési utasítás
- I** Impianto elettrico per gancio di traino Istruzioni di montaggio e per l'uso
- N** Elektrisk anlegg for tilhengerfeste Monterings- og bruksanvisning
- NL** Elektrische installaties voor aanhanger Montage- en gebruikshandleiding
- PL** Instalacja elektryczna do haka holowniczego Instrukcja montażu i eksploatacji
- RUS** Электрооборудование для фаркопа Инструкция по монтажу и эксплуатации
- S** Elsystem för dragkrok Monterings- och bruksanvisning

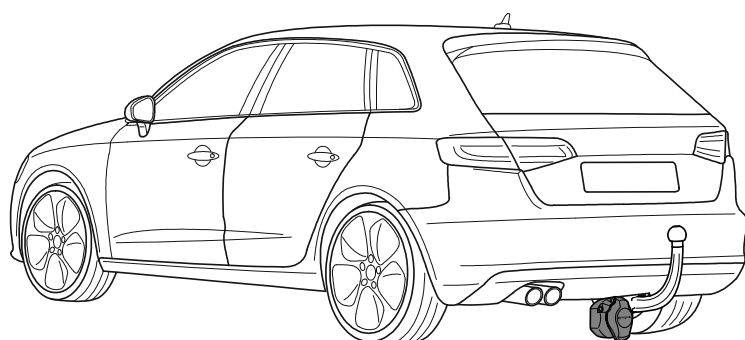

**305 408 300 107**

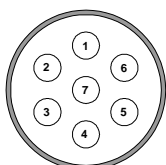

**305 408 300 113**

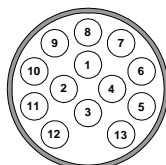

- Audi Q2**, 09/2016 →
- Audi Q3**, 11/2018 →
- Audi Q3 Sportback**, 11/2019 →
- Audi A3 (AB3)**, 06/2014 →
- Audi A3 Sportback (AB3)**, 06/2014 →
- Audi A3 Limousine**, 06/2014 →
- Audi A3 Cabrio**, 06/2014 →
- VW Golf VII**, 06/2014 →
- VW Golf VII Variant**, 06/2014 →
- VW Golf Sportsvan**, 06/2014 →
- VW Touran**, 10/2015 →
- VW Tiguan**, 05/2016 →
- VW Tiguan Allspace**, 09/2017 →
- VW Passat B8 Limousine**, 11/2014 →
- VW Passat B8 Variant**, 11/2014 →
- VW Arteon**, 03/2017 →
- VW Arteon Shooting Brake**, 11/2020 →
- VW T-Roc**, 09/2017 →
- VW T-Roc Cabrio**, 03/2020 →
- Seat Leon III**, 06/2014 →
- Seat Leon ST**, 06/2014 →
- Seat Tarraco**, 02/2019 →
- Seat Ateca**, 07/2016 →
- Cupra Ateca**, 10/2018 →
- Skoda Octavia III**, 06/2014 →
- Skoda Octavia Combi**, 06/2014 →
- Skoda Superb III Limousine**, 06/2015 →
- Skoda Superb III Combi**, 09/2015 →
- Skoda Kodiaq**, 03/2017 →
- Skoda Karoq**, 11/2017 →

- D** Vor Arbeitsbeginn die Einbauanleitung lesen. Die Elektroanlage für die Anhängervorrichtung darf nur von Fachpersonal montiert werden. Für technische Änderungen, und/oder Software-updates, die nach Erst-Inbetriebnahme, z.B. durch den Fahrzeughersteller, durchgeführt werden und zu Fehlfunktionen führen, kann keine Gewährleistung übernommen werden. Spezifische Anforderungen des Fahrzeugherstellers bezüglich Anhängerbetrieb sind zu beachten. Wir haften nicht für Schäden, die durch die Installation oder eine fehlerhafte Montage oder Nutzung des Produkts verursacht werden. **Der deutsche Text dieser Anleitung ist bindend.** Änderungen vorbehalten.
- CZ** Před zahájením práce si přečtěte montážní návod. Elektrickou sadu pro tažné zařízení může namontovat pouze odborný personál. Neneseme odpovědnost za nesprávné fungování v důsledku technických změn a/nebo aktualizací softwaru provedených po prvním uvedení do provozu například výrobcem vozidla. Dodržujte specifické požadavky výrobce vozidla s ohledem na provoz přívěsu. Neodpovídáme za škody způsobené instalací nebo nesprávnou montáží a používáním výrobku. **Závazný je německý text tohoto návodu.** Změny vyhrazeny.
- DK** Læs monteringsvejledningen, før du påbegynder arbejdet. Elsættet til anhængertrækket må kun monteres af fagpersonale. Vi påtager os ikke noget ansvar for tekniske ændringer og/eller softwareopdateringer, som udføres efter første ibrugtagning, f.eks. af køretøjsproducenten, og medfører fejlfunktioner ved brug af anhænger. Særlige krav fra køretøjsproducenten med hensyn til brug af anhænger skal overholdes. Vi er ikke ansvarlige for skader, som skyldes installationen eller forkert montering eller anvendelse af produktet. **Den tyske tekst i denne vejledning er bindende.** Forbehold for ændringer.
- E** Antes de empezar los trabajos, leer las instrucciones de montaje. Solo el personal especializado podrá montar la instalación eléctrica del dispositivo de remolque. No se aceptará ninguna garantía en caso de modificaciones técnicas o actualizaciones de software realizadas después de la puesta en servicio inicial, por ejemplo, por parte del fabricante del vehículo, y que provoquen fallos de funcionamiento durante el servicio. Se deben tener en cuenta los requisitos específicos del fabricante del vehículo en relación con el funcionamiento del remolque. No nos responsabilizamos de los daños que puedan surgir durante la instalación, un montaje inadecuado o el uso del producto. **El texto en alemán de estas instrucciones es vinculante.** Reservado el derecho a realizar modificaciones.
- F** Lire le manuel d'installation avant de commencer les travaux. L'installation électrique pour le dispositif d'attelage ne peut être réalisée que par du personnel qualifié. Aucune garantie ne peut être accordée pour les modifications techniques et/ou les mises à jour logicielles réalisées après la première mise en service, par exemple par le constructeur du véhicule, et qui entraînent des dysfonctionnements lors de l'utilisation. Les exigences spécifiques du constructeur du véhicule concernant l'utilisation de la remorque doivent être respectées. Nous ne sommes pas responsables des dommages causés par un montage ou une utilisation non conformes du produit. **Le texte allemand de ce manuel fait foi.** Sous réserve de modifications.
- FIN** Lue asennusohje ennen töiden aloittamista. Vetokokkun sähköjärjestelmän saa asentaa vain alan ammattilainen. Emme vastaa käytön aikana ilmenevistä toimintahäiriöistä, jotka ovat seurausta teknisistä muutoksista ja/tai ohjelmistopäivityksistä, jotka esim. ajoneuvon valmistaja suorittaa ensimmäisen käyttöönotton jälkeen. Ajoneuvon valmistajan erityisiä perävaunun käyttöön liittyviä vaatimuksia on noudatettava. Emme vastaa tuotteen asennuksesta tai virheellisestä kokoonpanosta tai käytöstä aiheutuvista vahingoista. **Tämä ohjeen saksalainen teksti on sitova.** Oikeus muutoksiin pidätetään.
- GB** Read the installation instructions before starting work. The electrical system for the towbar may only be fitted by qualified personnel. No warranty is given for any technical modifications and/or software updates carried out e.g. by the vehicle manufacturer after initial commissioning that cause malfunctions. Any specific requirements made by the vehicle manufacturer in respect of using a trailer must be complied with. We accept no liability for any damage or loss caused by the installation or the incorrect fitting or use of the product. **The German version of these instructions is binding.** Subject to change without notice.
- GR** Διαβάστε τις οδηγίες τοποθέτησης πριν από την έναρξη της εργασίας. Το ηλεκτρικό σύστημα για τον κοτσαδόρο επιτρέπεται να τοποθετείται μόνο από ειδικό προσωπικό. Δεν παρέχεται εγγύηση για τεχνικές μετατροπές και/ή ενημερώσεις λογισμικού που πραγματοποιούνται μετά από την πρώτη θέση σε λειτουργία, π.χ. από τον κατασκευαστή του οχήματος, και προκαλούν δυσλειτουργίες κατά τη λειτουργία ρυμούλκησης. Πρέπει να τηρούνται οι ειδικές απαιτήσεις του κατασκευαστή του χάρματος αναφορικά με τη λειτουργία ρυμούλκησης. Δεν αναλαμβάνουμε ευθύνη για ζημιές που προκαλούνται από την εγκατάσταση ή εσφαλμένη τοποθέτηση ή χρήση του προϊόντος. **Δεσμευτικό είναι το γερμανικό κείμενο αυτών των οδηγιών.** Με επιφύλαξη αλλαγών.
- H** A munkálatok megkezdése előtt olvassa el a beszerelési útmutatót. A vonószerkezet elektromos berendezését csak szakember szerelheti fel. Nem vállalható szavatosság azokra a – pl. a járműgyártó által – az első üzembe helyezés után végrehajtott műszaki módosításokra és/vagy szoftverfrissítésekre, amelyek a termék hibás működéséhez vezetnek üzemben. Be kell tartani a járműgyártó vonatkozó speciális követelményeit. Nem vállalunk felelősséget azokért a károkért, amelyek a telepítés vagy a termék helytelen összeszerelése vagy használata miatt keletkeznek. **A német nyelvű útmutatóban leírtak kötelező érvénnyel bírnak.** A változtatás jogát fenntartjuk.
- I** Prima di iniziare i lavori, leggere le istruzioni di montaggio. L'impianto elettrico per il gancio di traino può essere montato soltanto da personale specializzato. Non è possibile assumere alcuna garanzia per modifiche tecniche e/o aggiornamenti del software eseguiti dopo la prima messa in funzione, ad es. dal costruttore del veicolo, e che possono causare malfunzionamenti nell'esercizio. Rispettare i requisiti specifici del costruttore del veicolo riguardanti il funzionamento del rimorchio. Si declina ogni responsabilità per danni causati dall'installazione o da un montaggio o utilizzo errato del prodotto. **Il testo tedesco della presente istruzione è vincolante.** Con riserva di modifiche.
- N** Les monteringsveiledningen før du begynner å arbeide. Det elektriske anlegget til tilhengerfestet skal bare monteres av fagpersonale. Vi påtar oss intet ansvar for tekniske endringer og/eller programvareopdateringer som gjennomføres etter første idriftsetting, f.eks. av kjøretøyproduzenten, og som kan føre til feilfunksjoner. Spesifikke krav fra kjøretøyproduzenten med hensyn til tilhengerdrift, må tas hensyn til. Vi er ikke ansvarlige for skader som forårsakes under installasjonen eller på grunn av feilaktig montering eller bruk av produktet. **Den tyske teksten i denne veiledningen er bindende.** Med forbehold om endringer.
- NL** Vóór het begin van de werkzaamheden de inbouwhandleiding lezen. De elektrische installatie voor de koppelinrichting mag uitsluitend door vakpersoneel worden gemonteerd. Voor technische wijzigingen en/of software-updates die na de eerste inbedrijfstelling, bijv. door de voertuigfabrikant, worden uitgevoerd en storingen veroorzaken bij het bedrijf, kan geen garantie worden verleend. De specifieke vereisten van de voertuigfabrikant wat betreft het bedrijf met aanhangwagen moeten in acht worden genomen. Wij zijn niet aansprakelijk voor schade die door de installatie, een onjuiste montage of onjuist gebruik van het product wordt veroorzaakt. **De Duitse tekst van deze handleiding is bindend.** Wijzigingen voorbehouden.
- PL** Przed rozpoczęciem pracy należy przeczytać instrukcję montażu. Instalacja elektryczna haka holowniczego może być montowana wyłącznie przez wyspecjalizowany personel. Zmiany techniczne i/lub aktualizacje oprogramowania, które są przeprowadzane po rozruchu, np. przez producenta pojazdu, i skutkują awarią, nie są objęte gwarancją. Należy przestrzegać wymogów producenta pojazdu w zakresie jazdy z przyczepą. Nie odpowiadamy za szkody wynikające z instalacji lub nieprawidłowego montażu lub użytkowania produktu. **Niemiecka wersja tekstu jest wersją wiążącą.** Prawo do zmian zastrzeżone.
- RUS** Перед началом работ прочитайте инструкцию по монтажу. Устанавливать электрооборудование для сцепного устройства разрешается только специалистам. Гарантия не распространяется на технические изменения и/или обновления ПО, которые выполнены после ввода в эксплуатацию, например производителем автомобиля, и приводят к сбою. Соблюдайте специальные требования производителя автомобиля касательно эксплуатации прицепа. Мы не несем ответственность за повреждения, обусловленные установкой, неправильным монтажом или использованием изделия. **Немецкий текст данной инструкции является обязательным.** Компания сохраняет за собой право на внесение изменений.
- S** Läs monteringsanvisningen innan du börjar arbeta. Släpvnagskopplingen elsystem får endast monteras av fackkunnig personal. Garantin gäller inte för tekniska ändringar och/eller programuppdateringar som utförs efter första idrifttagningen, t.ex. av fordonstillverkaren, och som leder till feilfunktioner. Observera fordonstillverkarens specifika krav för släpvnagskopplingar. Vi ansvarar inte för skador som uppstår till följd av installationen eller felaktig montering eller användning av produkten. **Den tyska texten av denna anvisning är bindande.** Rätten till ändringar förbehålles.

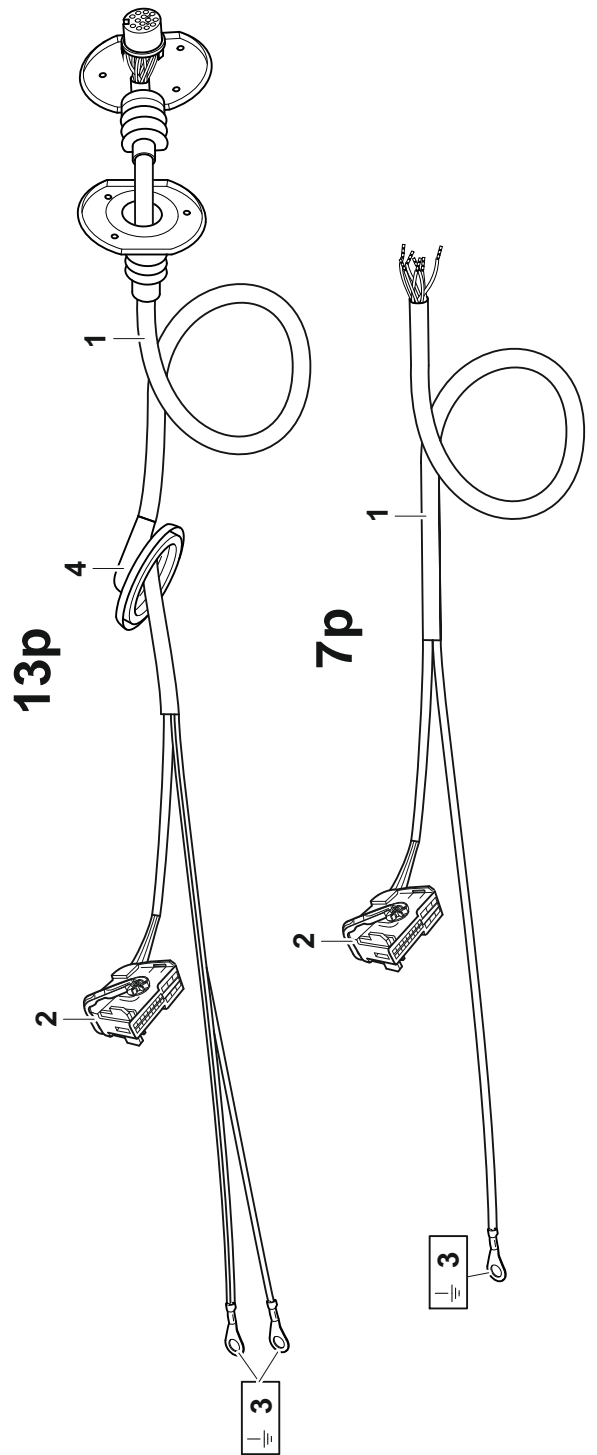
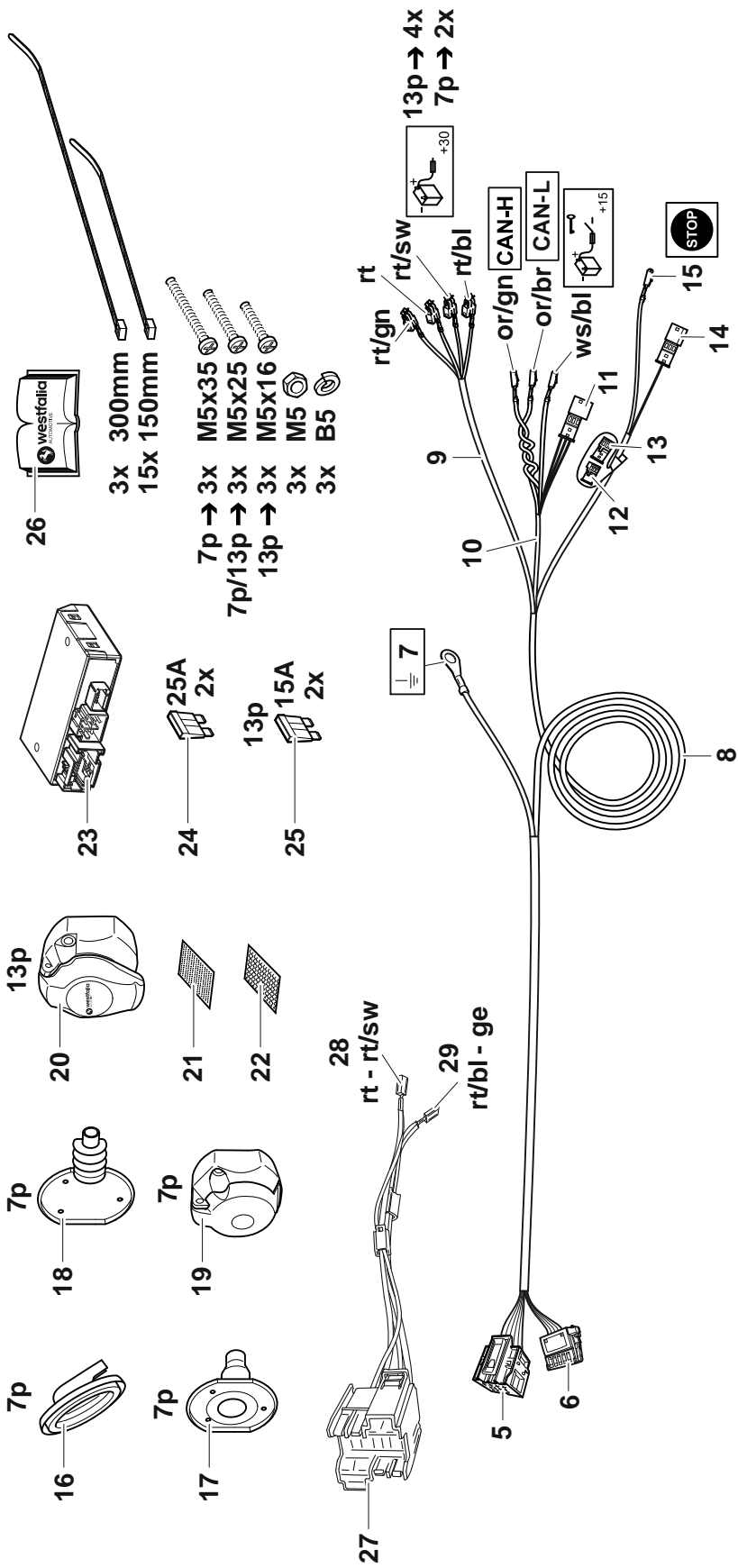

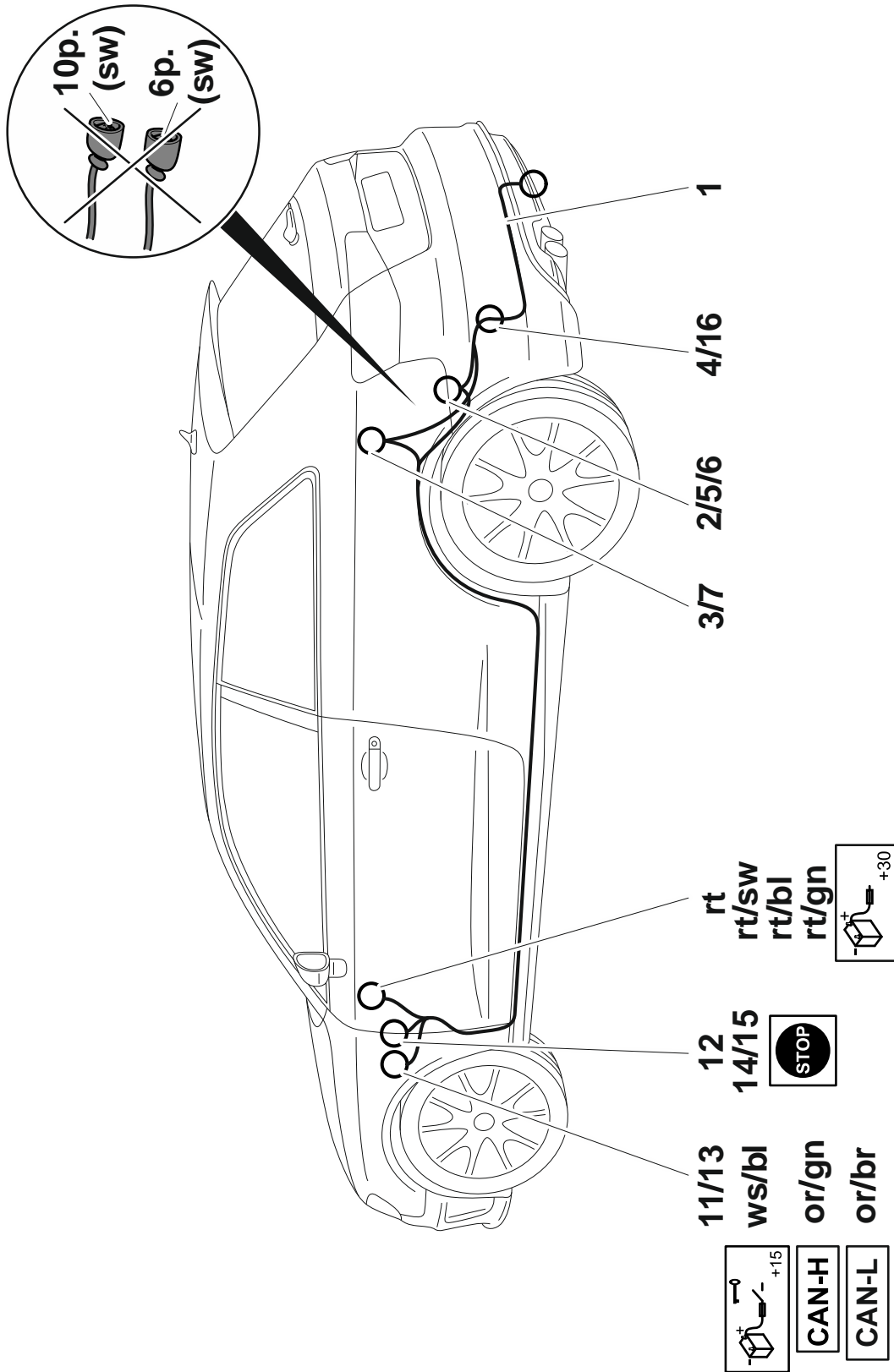

	dunkel	hell	sw	ws	br	gn	gr	rt	ge	bl	or	vi	rs
<b>D</b>	dunkel	hell	schwarz	weiß	braun	grün	grau	rot	gelb	blau	orange	violett	rosa
<b>CZ</b>	tmavý	bystrý	černo	bílá	hnědá	zelená	šedo	červená	žlutá	modrý	oranžový	fialový	růžová
<b>DK</b>	mørk	lyse	sort	hvid	brun	grøn	grå	rød	gul	blå	orange	violet	rosa
<b>E</b>	oscuro	claro	negro	blanco	marrón	verde	gris	rojo	amarillo	azul	anaranja-do	violeta	rosa
<b>F</b>	foncé	clair	noir	blanc	marron	vert	gris	rouge	jaune	bleu	orange	violet	rose
<b>FIN</b>	tumma	kirkas	musta	valkoinen	ruskea	vihreä	harmaa	punainen	keltainen	sininen	oranssi	violetti	rosa
<b>GB</b>	dark	light	black	white	brown	green	grey	red	yellow	blue	orange	purple	pink
<b>GR</b>	σκούρο	φωτεινό	μαύρο	λευκό	καφέ	πράσινο	γκρι	κόκκινο	κίτρινο	μπλε	πορτοκαλί	Μωβ	ροζ
<b>H</b>	sötét	fényes	fekete	fehér	barna	zöld	szürke	piros	sárga	kék	narancssárga	ibolyakék	rózsaszín
<b>I</b>	scuro	luminoso	nero	bianco	marrone	verde	grigio	rosso	giallo	blu	arancione	viola	rosa
<b>N</b>	mørk	lyse	svart	hvit	brun	grønn	grå	rød	gul	blå	oransje	fiolett	rosa
<b>NL</b>	donkere	heldere	zwart	wit	bruin	groen	grijs	rood	geel	blauw	oranje	violet	rosé
<b>PL</b>	ciemny	jasno	czarno	biały	brązowo	zielony	szaro	czerwony	żółty	niebieski	pomarańczowe	fioletowe	różowa
<b>RUS</b>	темно	светло	черный	белый	коричневый	зеленый	серый	красный	желтый	голубой	оранжевый	пурпур-ный	розовый
<b>S</b>	mörk	ljus	svart	vit	brun	grön	grå	röd	gul	blå	orange	violett	rosa









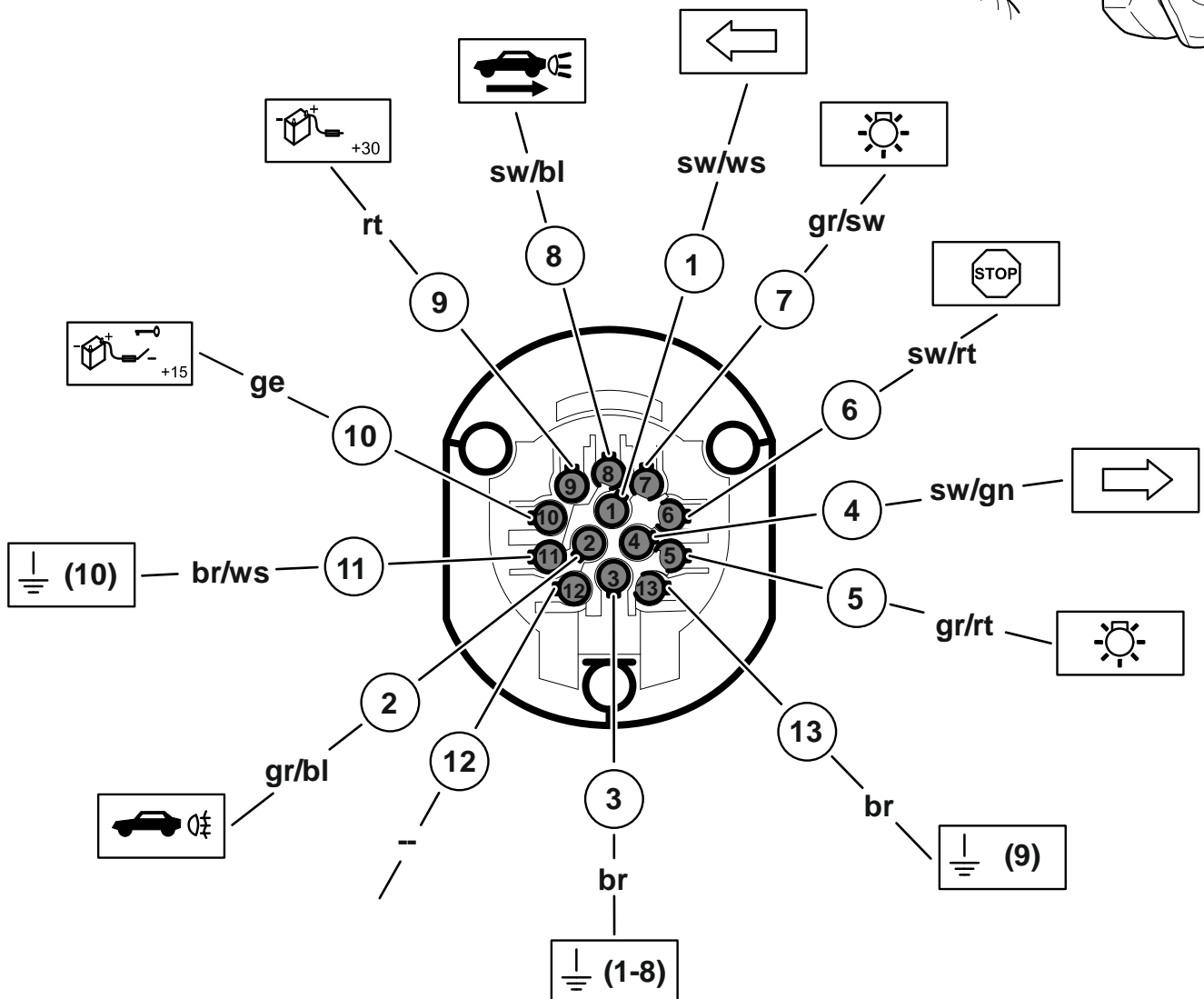
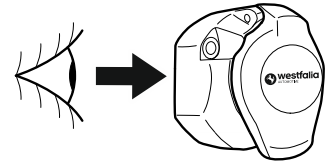



- D** Steckdosenbelegung
- E** Esquema de tomas de enchufe
- GB** Pin assignment
- I** Schema dei collegamenti della presa
- PL** Rozkład pinów

- CZ** Obsazení zásuvky
- F** Affectation des prises électriques
- GR** Αντιστοίχια πριζας
- N** Kontaktskjema
- RUS** Разводка розеток



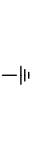
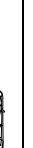

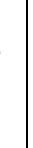



- DK** Koblingskema
- FIN** Pistorasian navat
- HU** Csatlakozódugó leosztása
- NL** Contactdoosbezetting
- S** Stickdosschema

## 12N ISO1724 ISO 11446

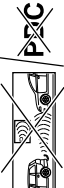
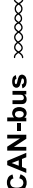
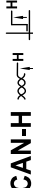
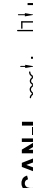

	D	CZ	DK	E	F	FIN	GB	GR	H	I	N	NL	PL	RUS	S
	Blinker links	Levé smerové svetlo	Blinker venstre	Indicador de dirección izquierda	Clignotant Gauche	Vilkku vasemmalle	left-hand indicator	Φλας αριστερά	villgö balra	Lampeggiat ore di sinistra	Blinklys venstre	Richtingaanwijzer links	Kierunkows. lewy	Световой сигнал поворота налево	Blinkers vänster
	Blinker rechts	Pravé smerové svetlo	Blinker højre	Indicador de dirección derecha	Clignotant droit	Vilkku oikealle	right-hand indicator	Φλας δεξιά	villgö jobbra	Lampeggiat ore di destra	Blinklys høyre	Richtingaanwijzer rechts	Kierunkows. prawy	Световой сигнал поворота направо	Blinkers höger
	Schalter Nebelschlußleuchte	Spínač zadních mlhových světel	Tågebagglygte	Interruptor Luz trasera antiniebla	Interrupteur Feu arrière de brouillard	Kytkin sumuvalo	rear fog lamp switch	Διακόπτης πίσω φωτός ομίχλης	hátsó ködlámpa kapcsoló	Interruttore fari fendinebbia	Bryter tåkebaklys	Schakelaar achtermistlicht	Przełącznik tylnego światła przeciwmgi.	Выключатель заднего светового туманного фонаря	Brytare dimbakljus
	Nebelschlußleuchte abgeschaltet	Zadní mlhová světla vypnuta	Tågebagglygte deaktivert	Luz trasera antiniebla apagada	Arrêt Feu arrière de brouillard	Sumuvalo pois päältä	rear fog lamp switched off	Διακόπτης πίσω φωτός ομίχλης απενεργ.	hátsó ködlámpa kikapcsolva	Fari fendinebbia spenti	Tåkebaklys slått av	Achtermistlicht uit	Tyne światło wyłączone	Задний противотуманный фонарь выключен	Dimbakljus släckt
	Standlicht Links und Rechts	Levé a pravé parkovací svetla	Venstre og højre parkeringlys	Luz de posición izquierda y derecha	Feux de position Gauche et droit	Seisontavalo vasen ja oikea	parking light left and right	Φωτα θέσης οπισθοπόδες ξά	állíthelyzetű ny baloldali és jobboldali	Luce di posizione di sinistra e di destra	Parkeringslys venstre og høyre	Standlicht links en rechts	Światło postojowe lewe i prawe	Стояночный свет слева и справа	Parkeringslys vänster och höger
	Stoplicht	Brzdová světla	Stoplys	Luz de freno	Feu de stop	Jarruvalo	brake lights	Φως стоп	Féklámpa	Luce dello stop	Stopplys	Stoplicht	Światło stop	Стоп-сигнал	Bromsly
	Rückfahr-scheinwerfer	Světlo zpátečky	Baklygte	Faro de marcha atrás	Phare de recul	Peruutusvalo	reversing lights	Προβολέας οπισθών	tolató fényoszó	Proiettori retrorarcia	Rygge-lys	Achteruitrijlicht	Światła cofania	Фары заднего хода	Bakstrålkastare
	Ladeleitung (aktiv bei eingeschalteter Zündung)	Nabíjecí kabel (aktivní při zapnutí a zapalování)	Ladeledning (aktiv når tændingen er slået til)	Cable de carga (activo con encendido conectado)	Câble de charge (actif à l'allumage connecté)	Latausjohto (aktiivinen sytytyksen ollessa päällä)	charging cable with ignition switched on	Αγωγός φόρτισης (ενεργός με ανάφλεξη)	töltővezeték (a gyújtás bekapcsolat állapotában aktív)	Cavo di carico (attivo ad accensione attivata)	Ladekabel (aktiv når tændingen er slått på)	Laadkabel (actief bij ingeschakelde ontsteking)	Przew. ład. (aktywny przy włączonym zapłonie)	Провод цепи заряда (активен при включенном зажигании)	Laddningsledning (aktiv vid tillägnad tändning)
	Dauerplus Leitung	Kladný kabel permanentnímu připojení	Konstant-plus ledning	Cable de positivo continuo	Câble positif permanent	Jatkuva plus-johto	permanent positive cable	Αγωγός συνεχούς θετικού	állandó pozitív vezeték	Linea maggiore durata	Permanent positiv ledning	Kabel permanent positief	Przewód stay plus	Постоянный положительный кабель	Permanente plus-ledning
	Masseanschluss	Uzemnění	Stel forbindelse	Conexión a masa	Connexion de masse	Maadotusliitäntä	ground connection	Σύνδεση γείωσης	csatlakozó	Collegamento massa	Jordtilkobling	Massa-aansluiting	Przyłącze masy	Замыкание на массу	Jordanslutning
	Schalter im Fahrzeug	Spínač ve vozidle	Kontakt i køretøj	Interruptor en el vehículo	Interrupteur dans le véhicule	Kytkin ajoneuvossa	switch in vehicle	Διακόπτης στο όχημα	kapcsoló a járműben	Interruttore sul veicolo	Bryter i kjøretøyet	Schakelaar in het voertuig	Przełącznik w pojeździe	Выключатель в автомобиле	Brytare i fordonet
	Fahrzeugleuchten hinten	Koncová světla	Køretøj baglygter	Luces de vehículo atrás	Feux arrière véhicule	Ajoneuvovalot, taka	rear vehicle lights	Πίσω φώτα οχήματος	jármű hátsó világítások	Luci veicolo posteriori	Kjøretøyllys bak	Voertuig-lichten achteraan	Światła pojazdu z tyłu	Задние фары	Fordonslampor bak
	Achtung! Hohe Temperatur	Pozor! Vysoká teplota	OBS! Høj temperatur	¡Atención! Alta temperatura	Attention! Température élevée!	Huomio! Korkea lämpötila	Warning! high temperature	Προσοχή! Υψηλή θερμοκρασία	Figyelem! Magas hőmérséklet	Attenzione! Temperatura elevata	Obs! Høy temperatur	Opgelet! Hoge temperatuur	Uwaga! Wysoka temperatura	Внимание! Высокая температура	Observerat! Hög temperatur
	Steuerggerät Anhängerrichtung	Řídicí jednotka tažného zařízení	Styretheda tilhørende anordning	Equipo de control Dispositivo de remolque	Boîtier électronique Dispositif de remorque	Perävaunun ohjauslaitte	control module trailer tow-bar	Μονάδα ελέγχου διάταξης ρυθμίζουσας	vonatíó eszköz vezérlő készülék	Quadro dei comandi unità rimorchio	Styrethet tilhengermek anisme	Regelaar trekhaakinstallatie	Urządzenie sterujące urządzeniem holowniczym	Блок управления прицепа устройства	Styrdon släpans anordning



	D	CZ	DK	E	F	FIN	GB	GR	H	I	N	NL	PL	RUS	S
	keine Feuchtigkeit	Žádná vlhkost	Ingen fugtighed	No hay humedad	Pas humidité	ei kosteutta	no lubrication	όχι υγρασία	nedvessøget	assenza di umidità	ingen fuktighet	Geen vocht	Brak wilgoci	Нет жидкости	ingen fukt
	LED Prüf Lampe	Zkušební LED svítlna	LED testlampe	Lámpara de prueba de LED	Lampe de contrôle à diode	LED tarkastuslamppu	LED test lamp	Λυχνία ελέγχου LED	LED ellenőrző lámpa	Luce di verifica LED	LED testlampe	LED control-lampje	Lampka kontrolna LED	Светодиодная контрольная лампа	LED kontrolllamp
	Rechtslenker	Pravostranné řízení	Højrestyret	con dirección a la derecha	Direction à droite	Ohjaus oikealla puolella	right-hand drive vehicle	Δεξιόημιόριο	jobb kormány	Guida a destra	Ratt på høyre side	Stuur rechts	Kierownica z prawej strony	Автомобиль с правосторонним расположением рулевого управления	Högerstyrt fordon
	Linkslenker	Levostranné řízení	Venstre styret	con dirección a la izquierda	Direction à gauche	Ohjaus vasemmalla puolella	left-hand drive vehicle	Αριστερόημιόριο	balkormány	Guida a sinistra	Ratt på venstre side	Stuur links	Kierownica z lewej strony	Автомобиль с левосторонним расположением рулевого управления	Vänsterstyrt fordon
	mit Einparkhilfe	S parkovací asistenten	Med parkeringshjelp	con asistencia de estacionamiento	Avec aide au stationnement	Pysäköinti-apu	with parking aid	Με σύστημα παρακαρπάριατος	beparkolási támogatással	con ausilio al parcheggio	med parkeringsassistent	Met parkeer-sensor	z asystentem parkowania	С парковочным радаром	med parkeringshjelp
	ohne Einparkhilfe	Bez parkovací asistentia	Uden parkeringshjelp	sin asistencia de estacionamiento	Sans aide au stationnement	Ei pysäköinti-apua	without parking aid	Χωρίς σύστημα παρακαρπάριατος	beparkolási támogatás nélkül	senza ausilio al parcheggio	uten parkeringsassistent	Zonder parkeer-sensor	bez asystenta parkowania	Без парковочного радара	utan parkeringshjelp
	Datenbusleitung (CAN)	Datový kabel sběrnice CAN	Databusledning (CAN)	Cable de bus de données (CAN)	Câble de bus de données (CAN)	Tietoväylä (CAN)	data bus cable (CAN)	Αγωγός δαύλου δεδομένων (CAN)	adatsbus vezetékek (CAN)	Linea bus di dati (CAN)	Databusledning (CAN)	Gegevensbuslijn (CAN)	Przewód magistrali danych (CAN)	Однопроводная шина данных (CAN)	Databusledning (CAN)
	CAN High Signal	Vysokovýšňi sběrnice CAN	CAN High signal	Señal CAN High	Signal CAN haut	CAN - signaali korkeaa	CAN high signal	Σήμα CAN High	CAN High jel	Segnale CAN High	CAN High-signal	CAN High Signal	CAN High Signal	Сигнал CAN High	CAN High Signal
	CAN Low Signal	Nizkovýšňi sběrnice CAN	CAN Low signal	Señal CAN Low	Signal CAN faible	CAN - signaali matala	CAN low signal	Σήμα CAN Low	CAN Low jel	Segnale CAN Low	CAN Low-signal	CAN Low Signal	CAN Low Signal	Сигнал CAN Low	CAN Low Signal
	Karosserie-loch bohren und versiegeln	Vývrtat díru do karosérie a následně ji zapravit	Bor og forsegl hulversigling	Perforar agujero de carrocería y sellarlo	Perçage et masticage des trous de carrosserie	Kori, poraa reikä ja tiivistä	drill and seal bodywork hole	Διτρώει και σφραγίζει το όπλις στο αυτοζώμα	lyuk fúrás a karosszeriár a eszárás	Trapanare e sigillare i fori carrozzeria	Bore og forsegle hull i karosseriet	Carosserie-gat boren en verzegele	Wykonać otwór w karoserii i zabezpiecz.	Просверлить и запечатать отверстие в кузове	Borra och forsegl karosshål
	Klebeband	Lepicí páska	Tape	Cinta adhesiva	Ruban adhésif	Liimanauha	adhesive tape	Κολλητική ταινία	ragasztószalag	Nastro adesivo	Limbånd	Kleefband	Tasma klejaca	Клейкая лента	Tejp
	Radio Codierung beachten	Pozor na kód rádia	Bemærk radio kodning	Tener en cuenta código radio	Attention à la codification radio	Huomaa radio-koodeaus	observe radio coding	Προσοχή στην συμπαικτική κωδικοποίηση	a rádió kódolására figyelni	Rispettare codifica radio	Vær opmærksom på radio kodning	Radio-codering in acht nemen	Uwzględnić kodowanie radia	Учитывать кодировку радио	Observera radiokodning
	Achtung! Säure	Pozor! Kyseliny	OBS! Syre	¡Atención! Acido	Attention ! Acide	Huomio! Happoa	Warning! acid	Προσοχή! Οξύ	Figyelem! Sav	Attenzione! Acido	Obs! Syre	Opgelet! Zuren	Uwaga! kwas	Внимание! Кислота	Observera Syra





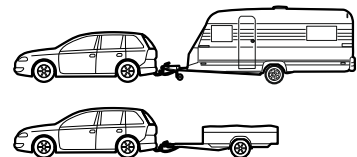
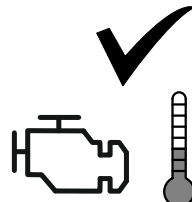
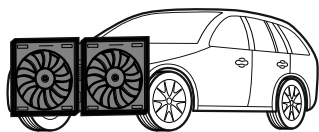
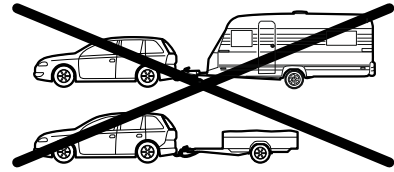
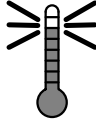
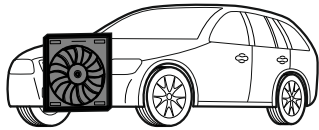
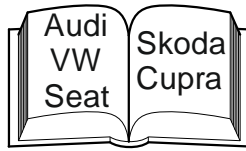
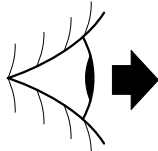

- D** ! Achtung ! Es ist sicherzustellen das alle Anforderungen des Fahrzeughersteller zu Änderungen und Nachrüstungen am Fahrzeug und/oder Kühlsystem für den Betrieb mit Anhänger durchgeführt wurden.
- E** ! Atención ! Se debe asegurar que se ha cumplido con todos los requerimientos del fabricante del vehículo en lo que respecta a modificaciones y reequipamiento en el vehículo y/o sistema de refrigeración para la operación con remolque.
- F** ! Attention ! Il convient de s'assurer que toutes les consignes imposées du fabricant du véhicule ont été respectées concernant les modifications et les équipements ultérieurs réalisés sur le véhicule et/ou le système de refroidissement pour l'utilisation avec la remorque.
- GB** ! Warning ! It must be ensured that all the requirements of the vehicle manufacturer for changes to and retro-fitting on the vehicle and / or cooling system for the operation with a trailer are carried out.
- I** ! Attenzione ! Occorre controllare che vengano rispettati tutti i requisiti del costruttore del veicolo relativi alle modifiche e agli accessori sul veicolo e/o sull'impianto del raffreddamento per l'esercizio del rimorchio.
- NL** ! Opgelet ! Zorg ervoor dat voor de werking met aanhangwagen aan alle eisen van de voertuigfabrikant i.v.m. veranderingen en wijzigingen aan het voertuig en/of koelsysteem werd voldaan.

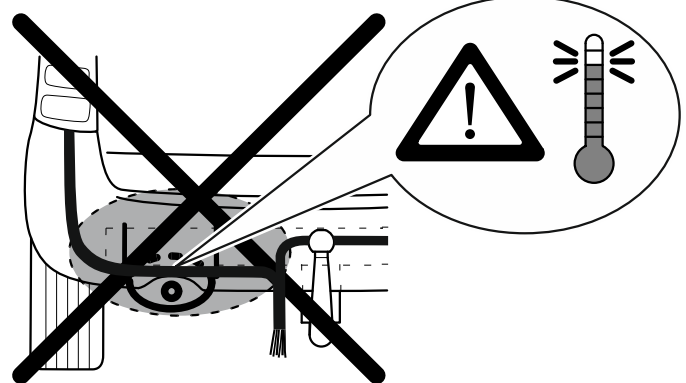
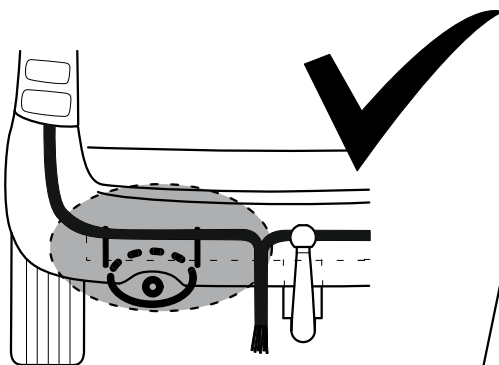

**siehe Seite 28**  
**see page 28**

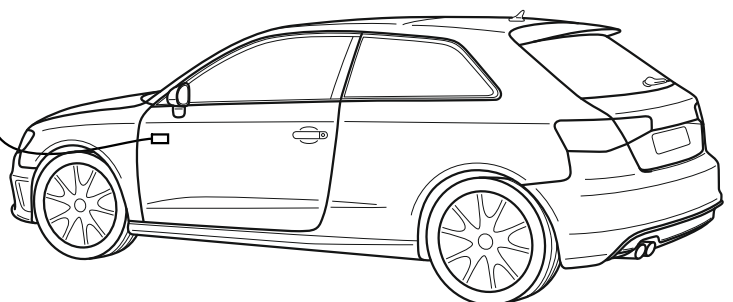
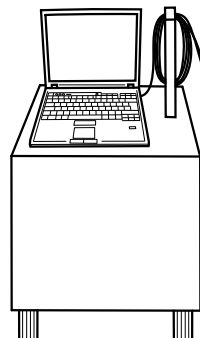

- 1**
- D** Achtung – vor Arbeitsbeginn den Fehlerspeicher auslesen. Batterie abklemmen, um Beschädigungen der KFZ- Elektronik zu vermeiden.
  - E** Atención – antes de iniciar la tarea, leer la memoria de fallos. Desconecte la batería para evitar daños en la instalación eléctrica del vehículo.
  - F** Attention – Avant de commencer le travail, éliminer l'ensemble des défauts présents dans la mémoire de l'ordinateur de bord . Débrancher la batterie afin d'éviter tout endommagement de l'installation électronique du véhicule.
  - GB** Attention – before starting to work, read out the errors stored in the memory. Disconnect the battery to prevent damage to the vehicle electronics.
  - I** Attenzione – prima di iniziare i lavori, leggere la memoria errori. Scollegare la batteria al fine di evitare danni all'impianto elettronico del veicolo.
  - NL** Attentie – voor montage het foutgeheugen aflezen. Los de accu klemmen om beschadiging van de voertuigelektroniek te vermijden.

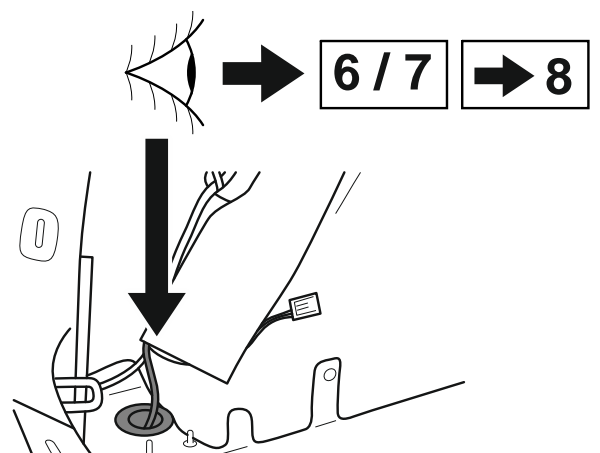
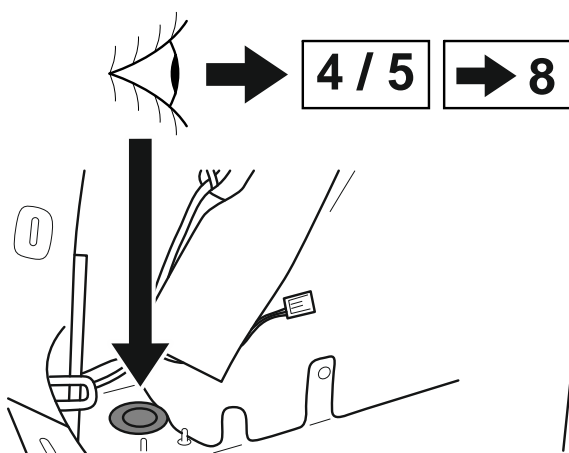
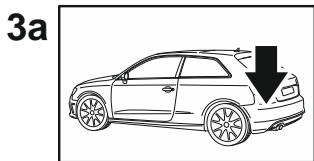
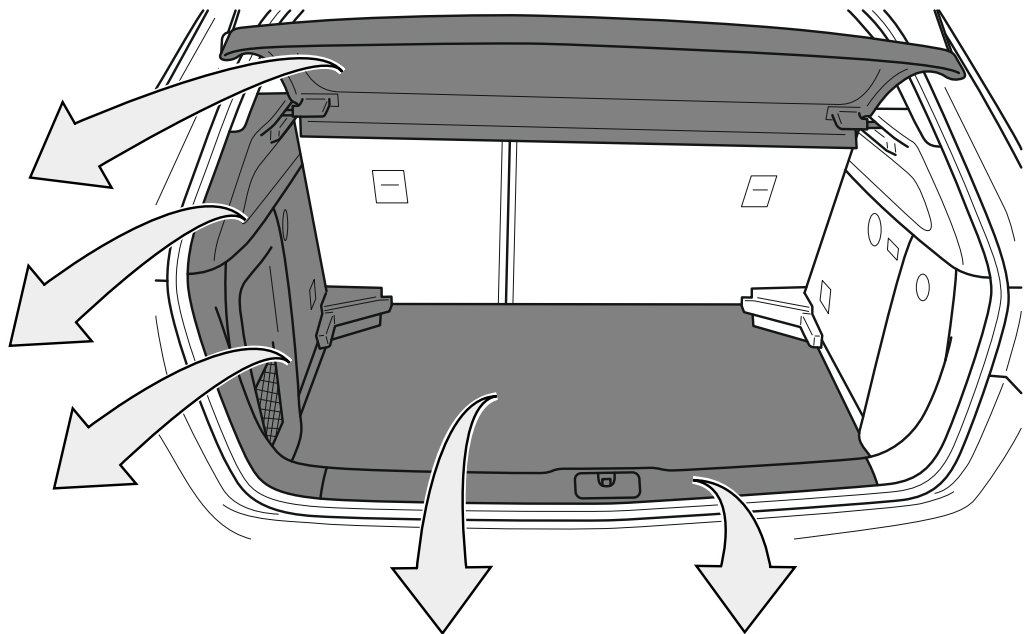
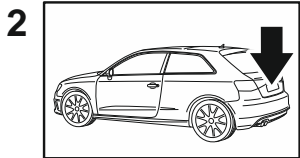
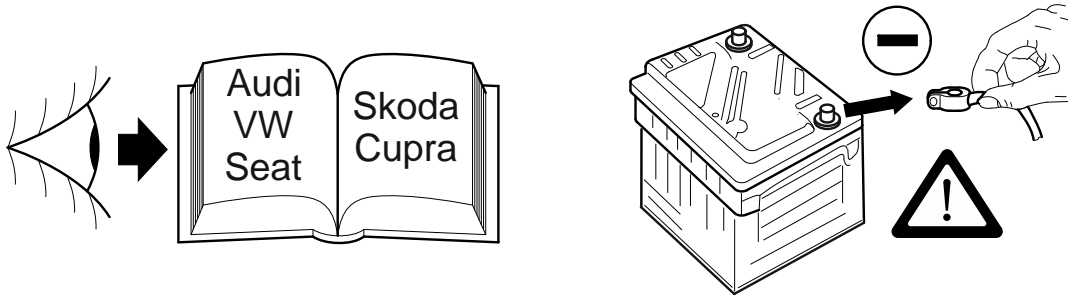

3b

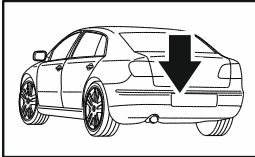

Arteon  
Passat B8  
Superb III  
Octavia

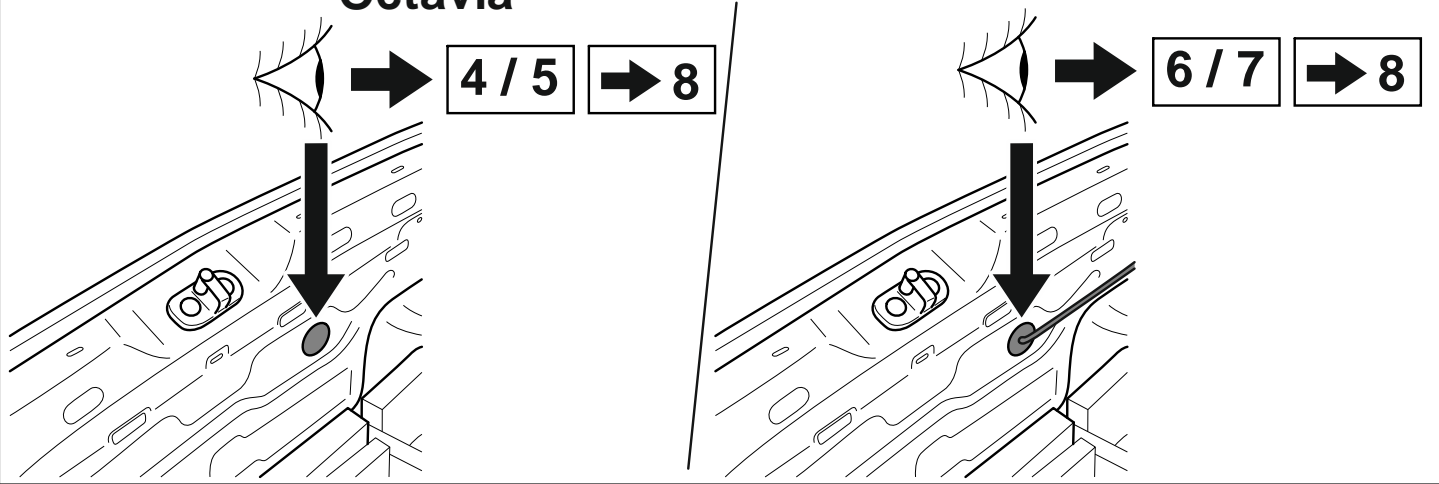

4

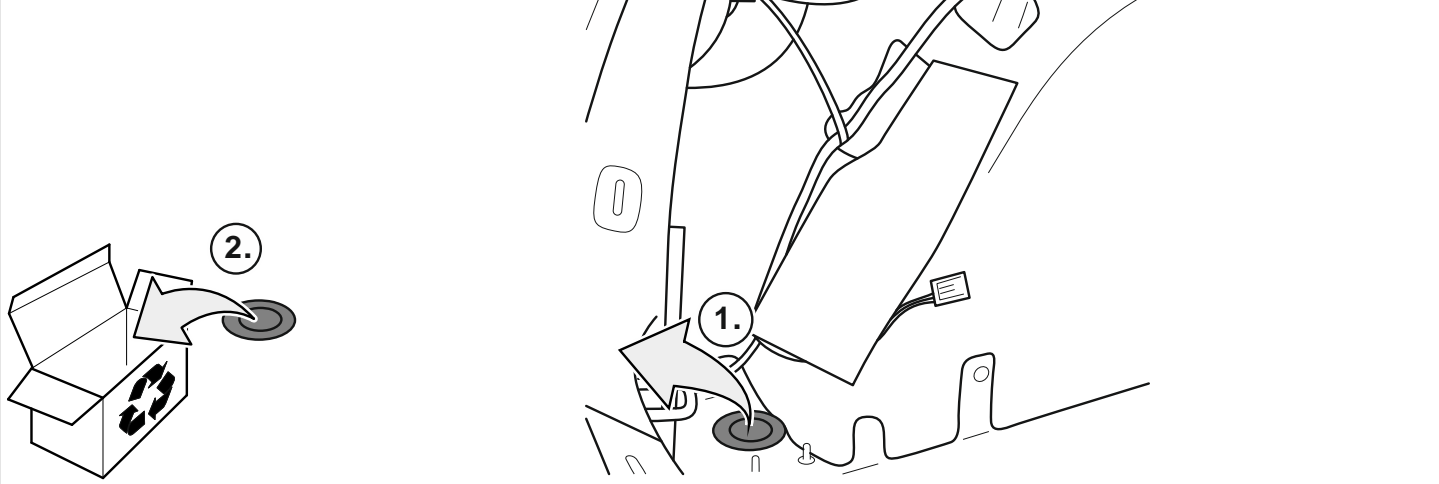
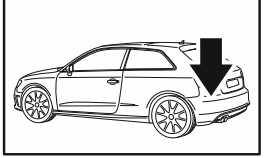

5

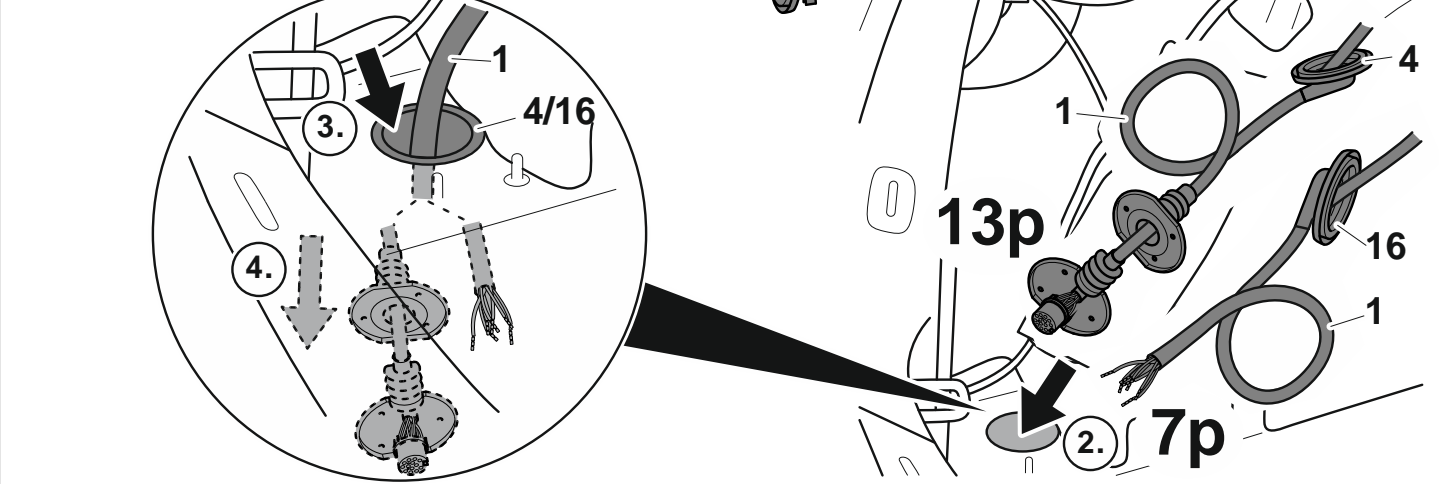
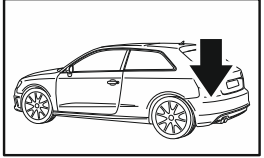

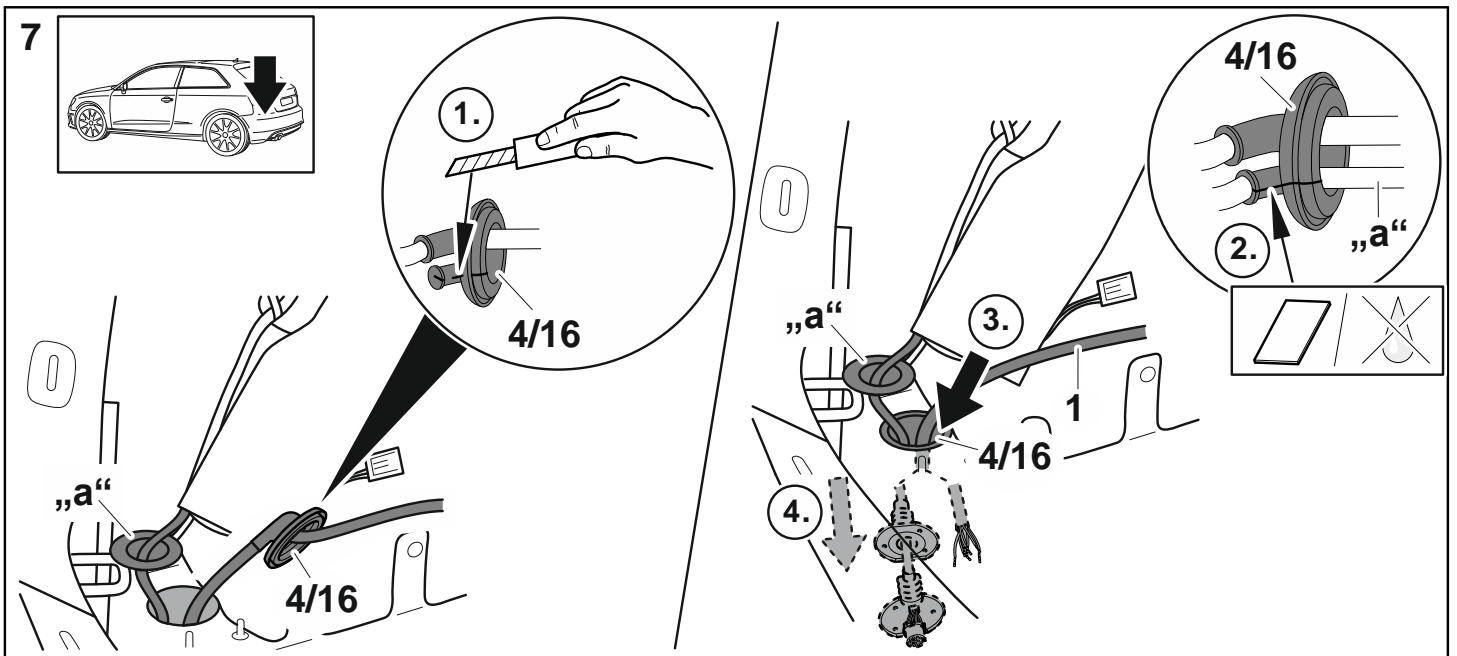
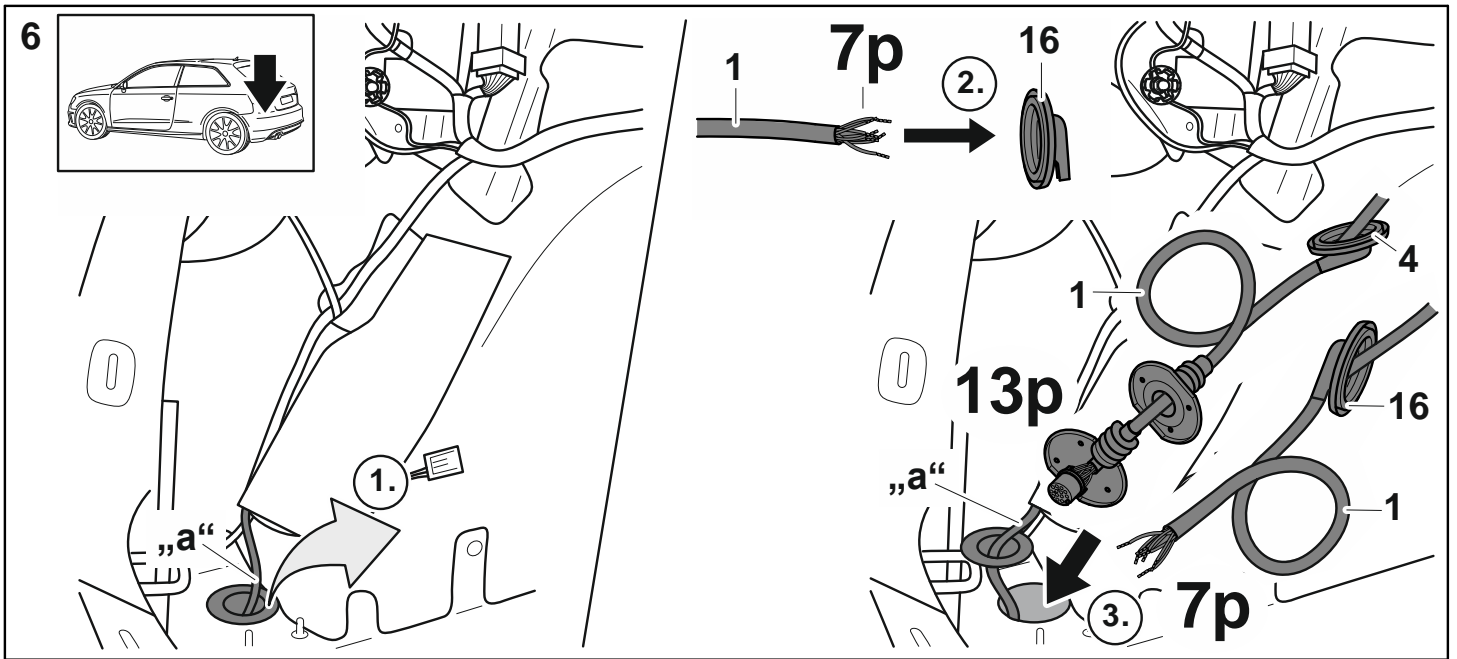

8a

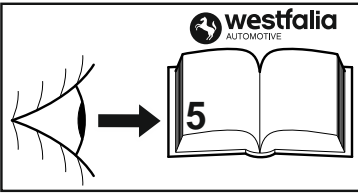

7p

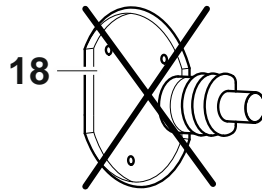

- 3x M5x35
- 3x M5x25
- 3x M5
- 3x B5

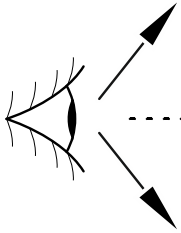
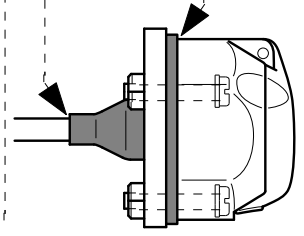
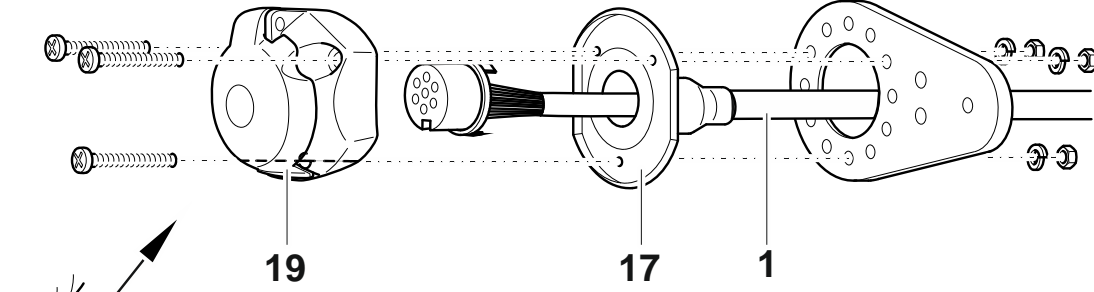
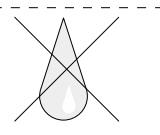

7p

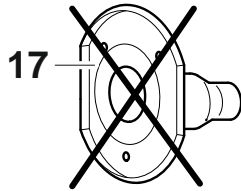

- 3x M5x35
- 3x M5x25
- 3x M5
- 3x B5

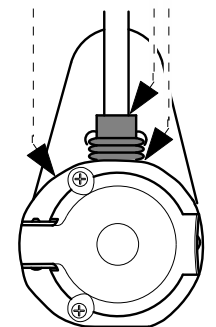
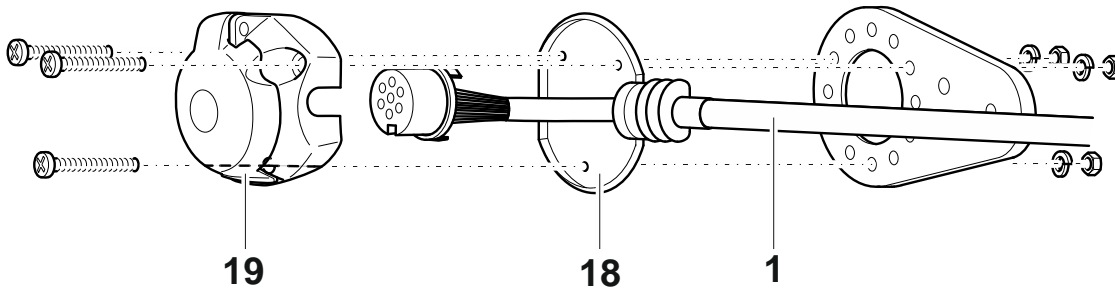
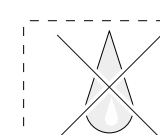



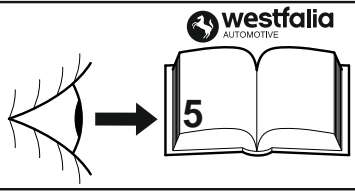

8b

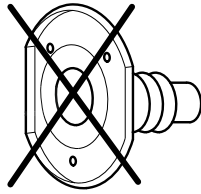

13p





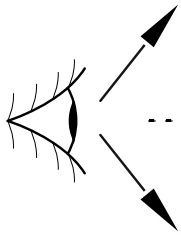
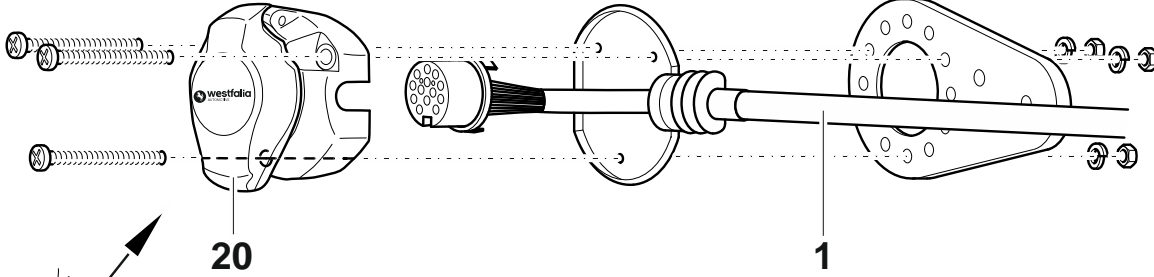
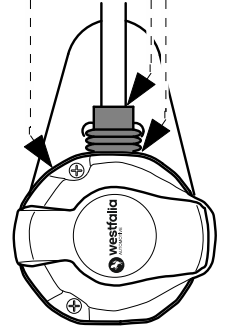

- 3x M5x25 
- 3x M5x16 
- 3x M5 
- 3x B5 

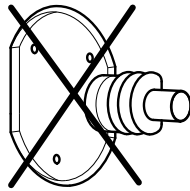

13p



- 3x M5x25 
- 3x M5x16 
- 3x M5 
- 3x B5 

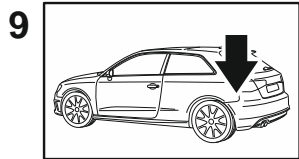
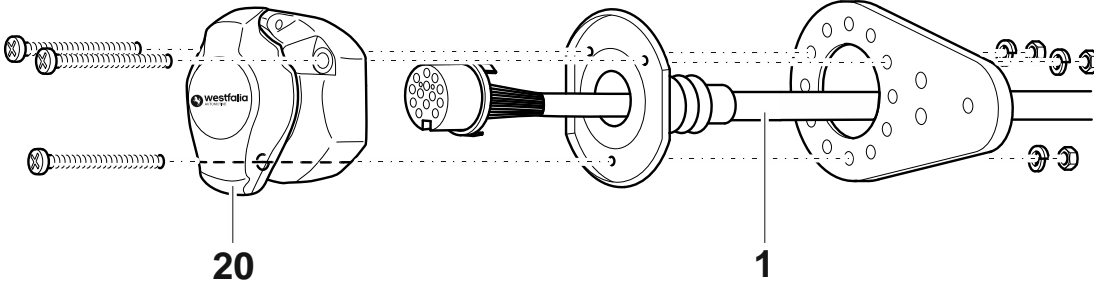
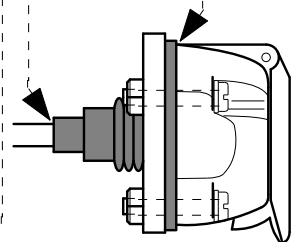

9

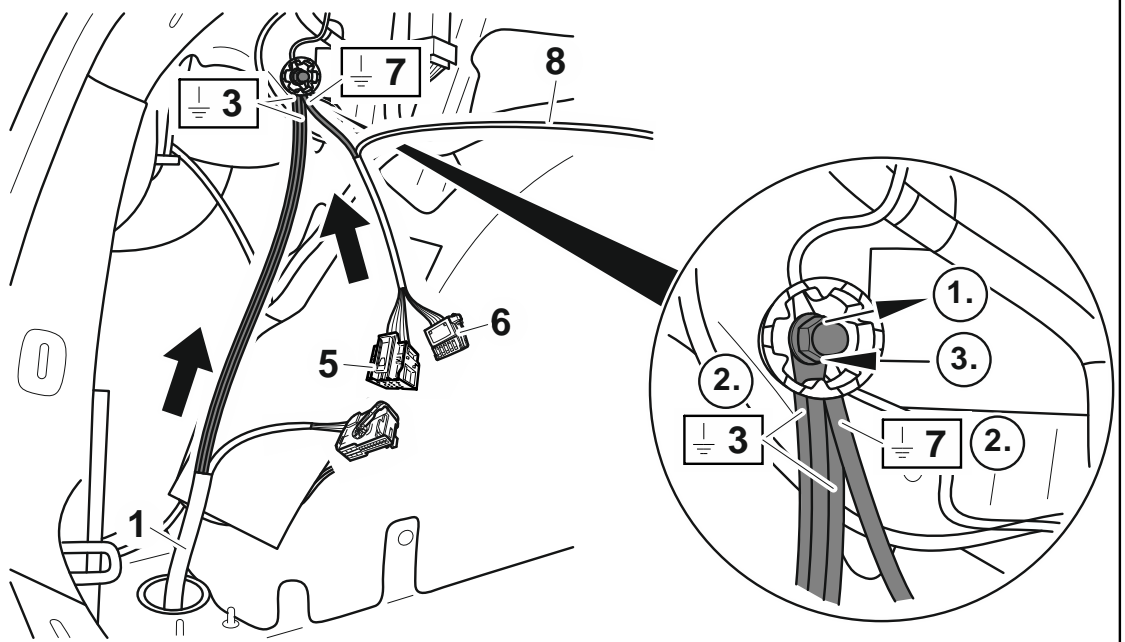



10

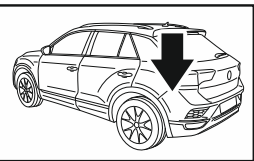
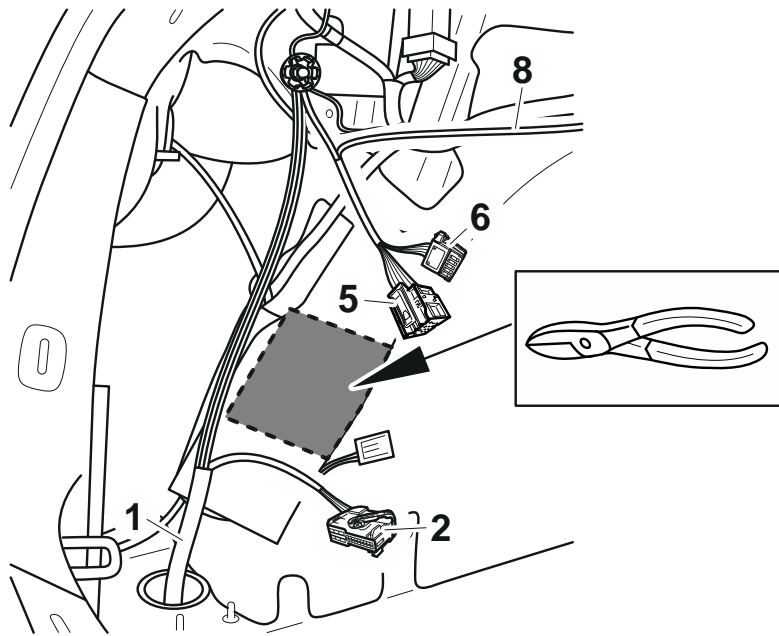
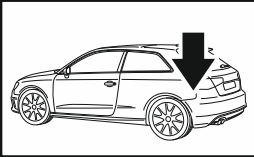

**T-Roc  
Karoq  
Ateca**

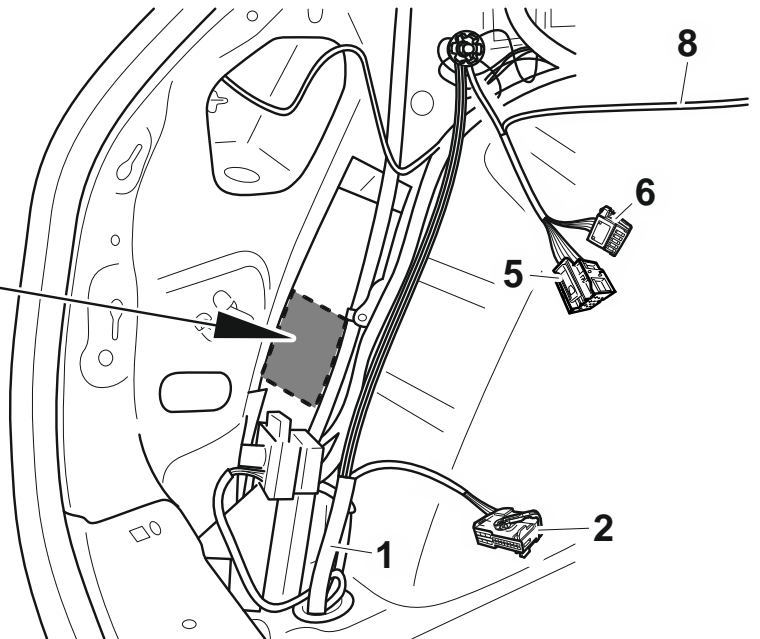
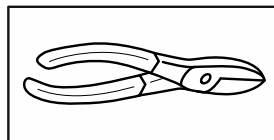

11

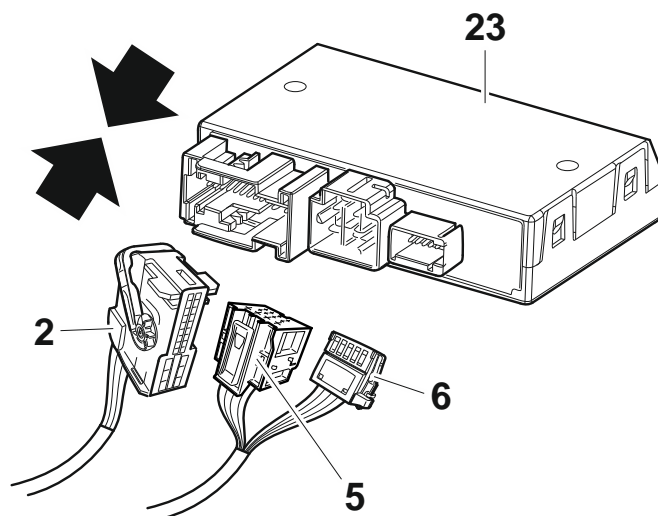
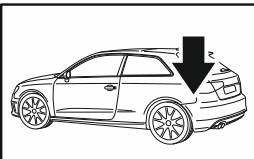

12

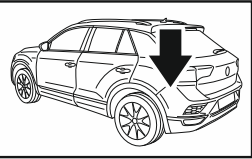
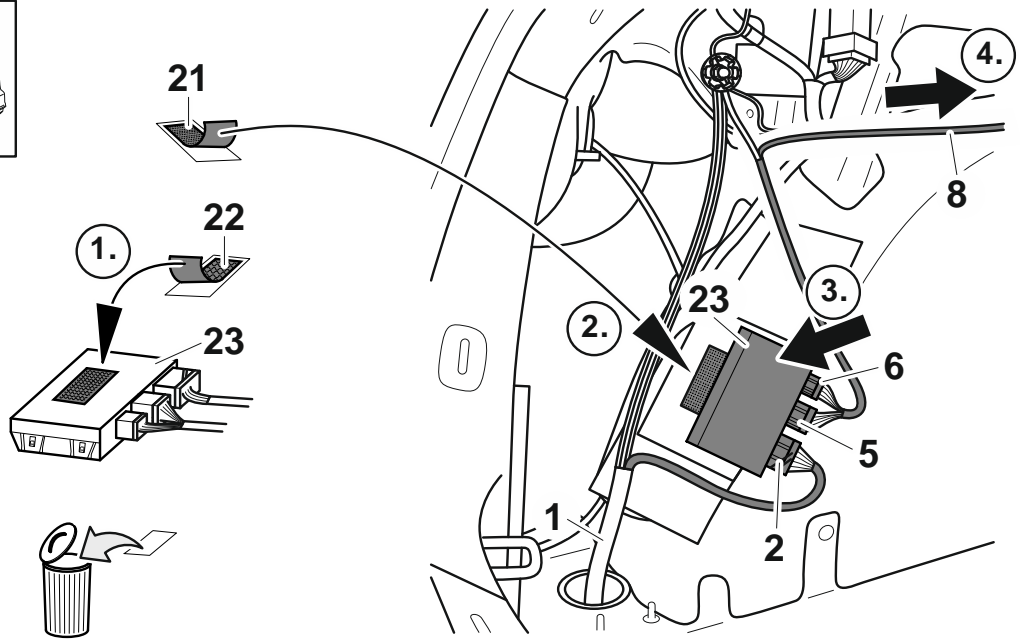
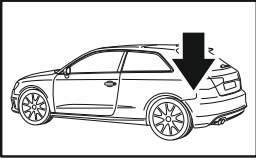

**T-Roc  
Karoq  
Ateca**

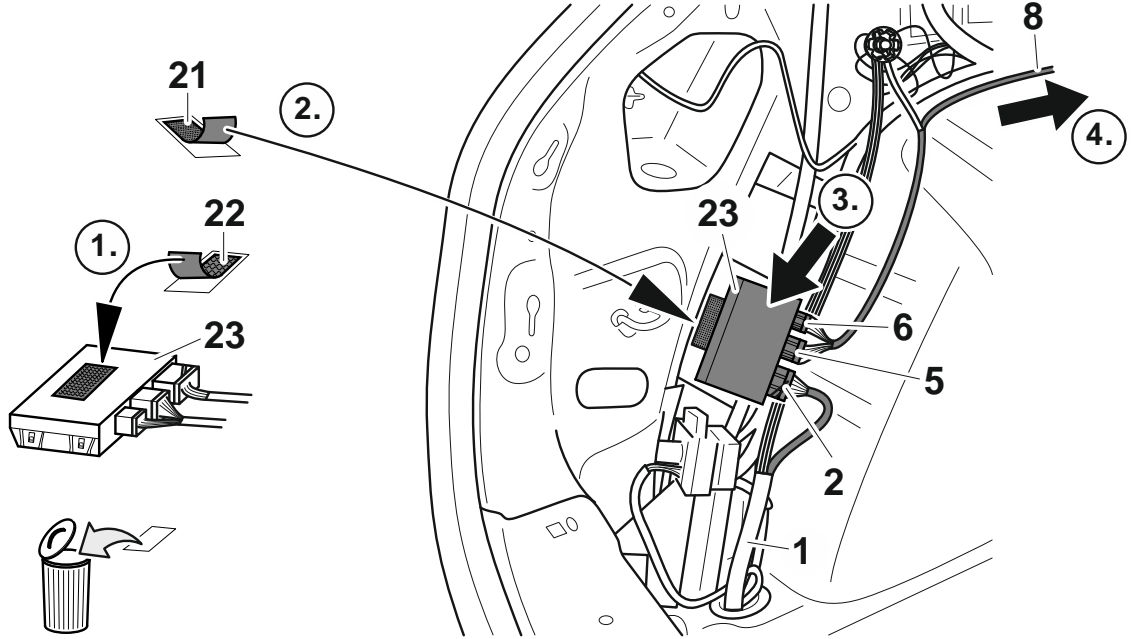

13

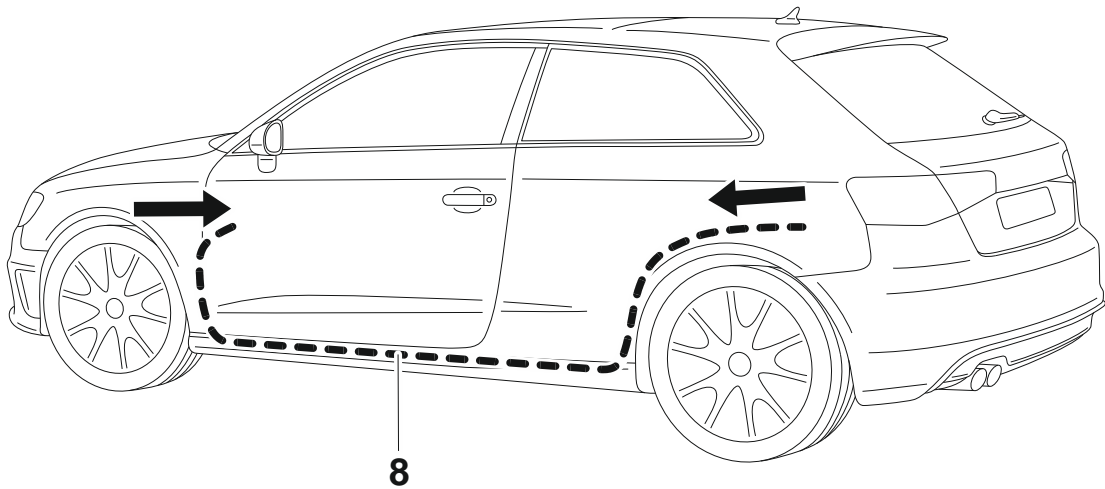

14

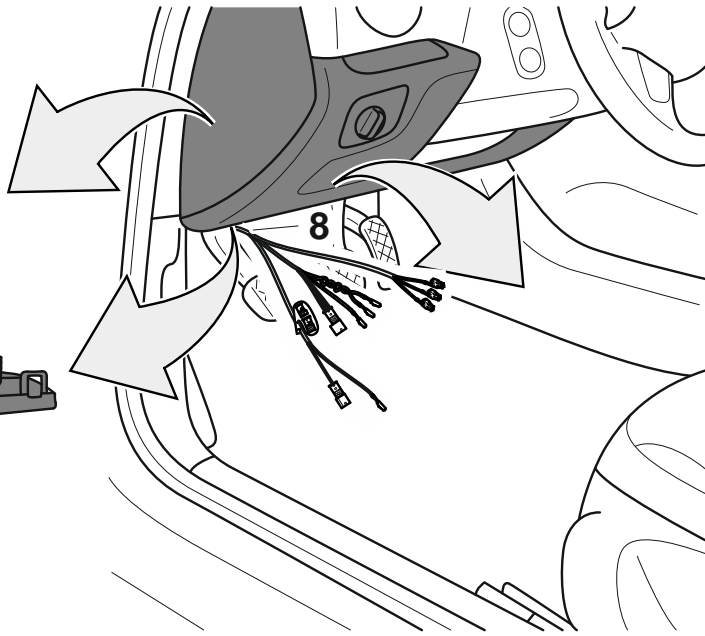
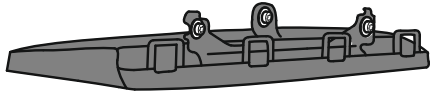
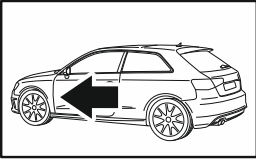

15

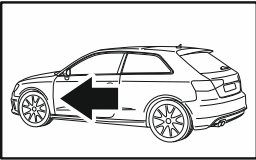

BCM

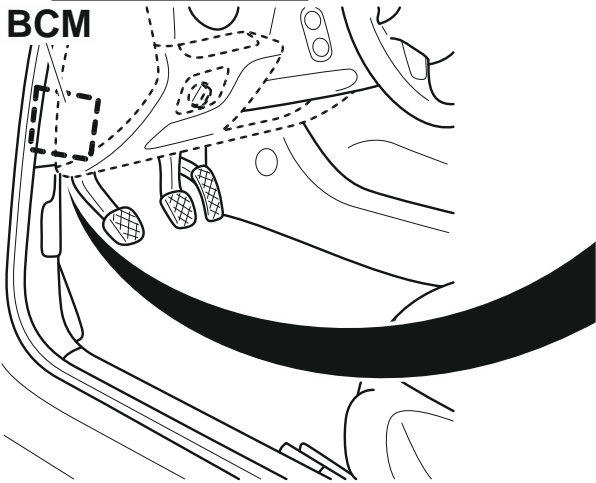

BCM

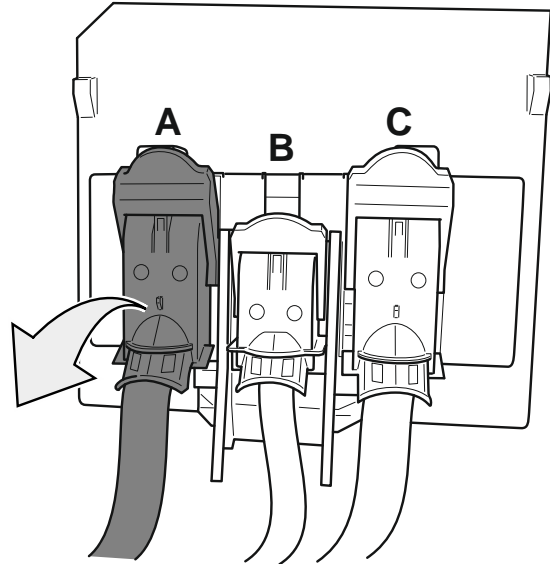

16

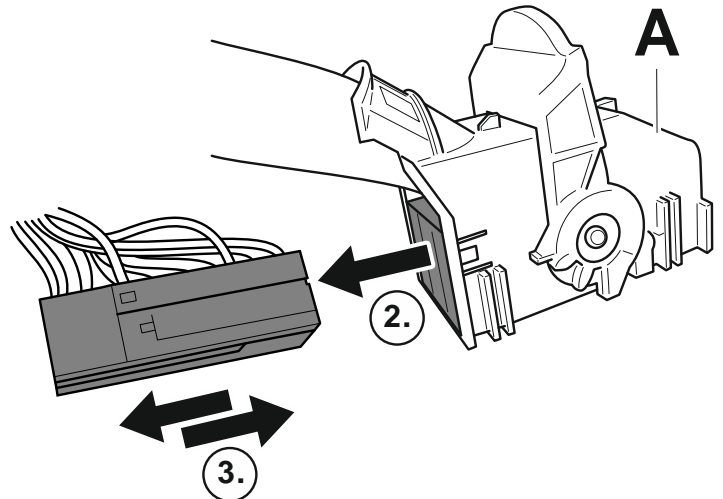
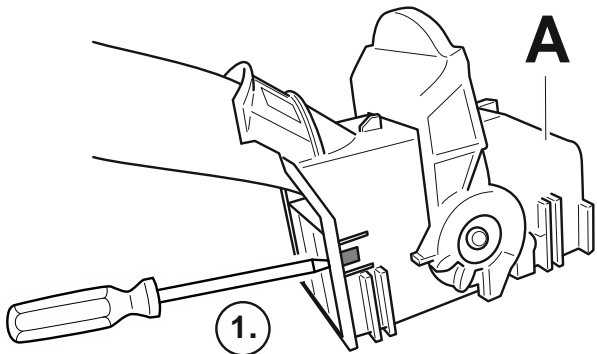

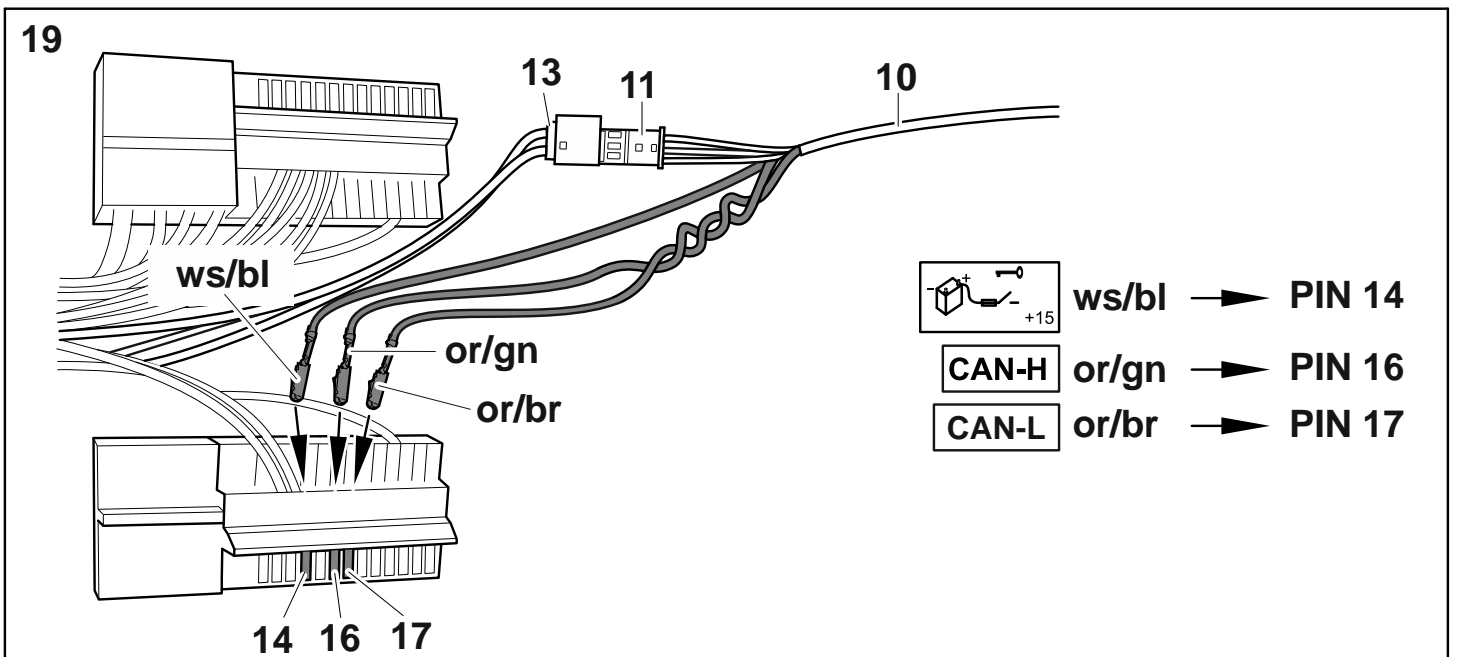
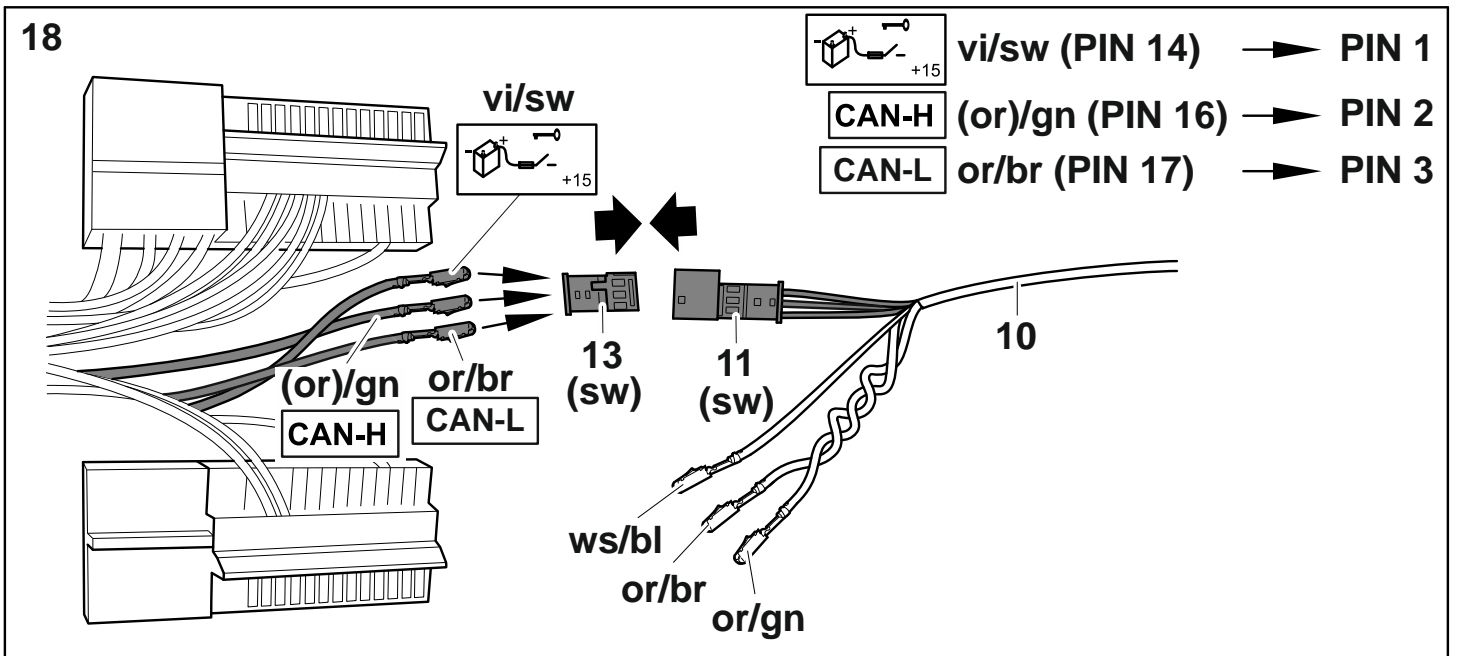
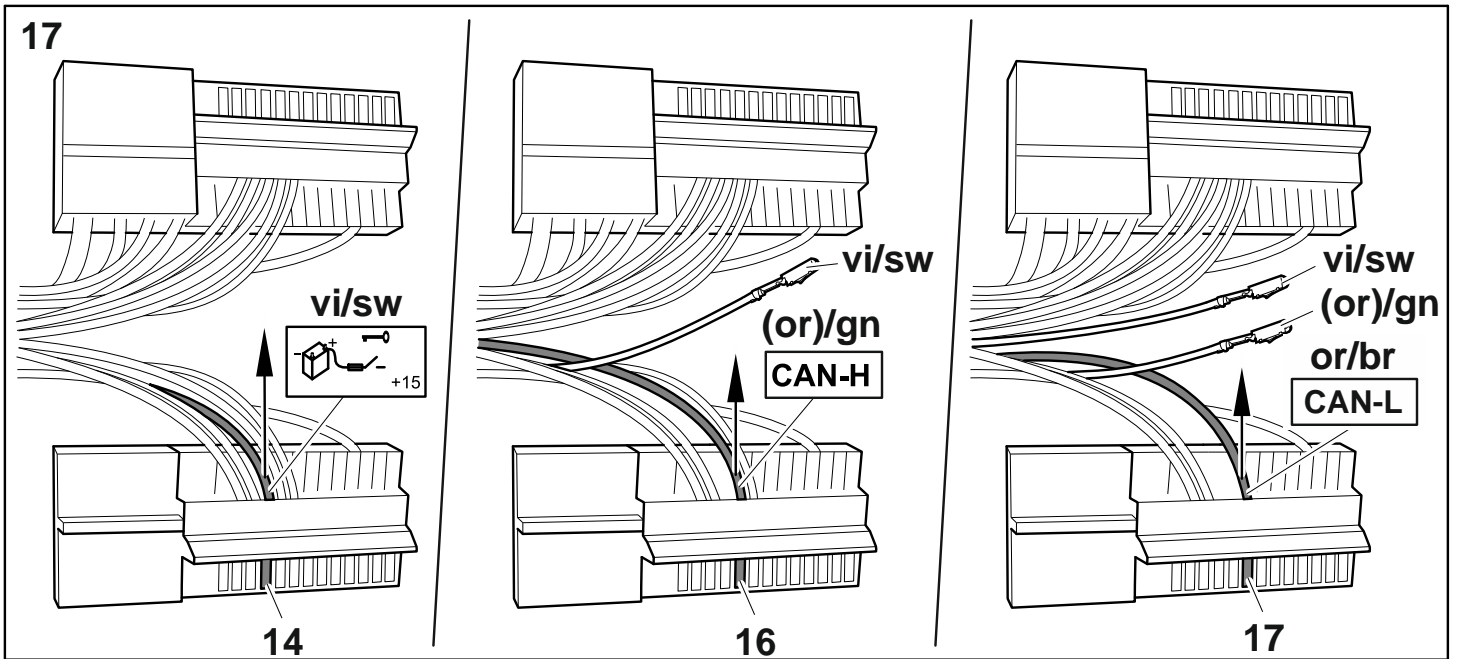

20

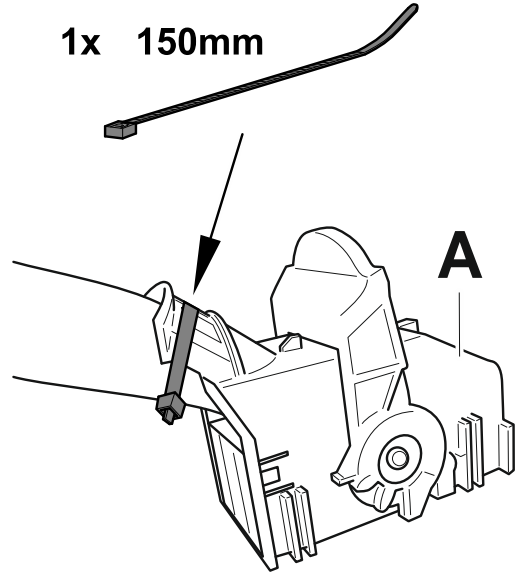
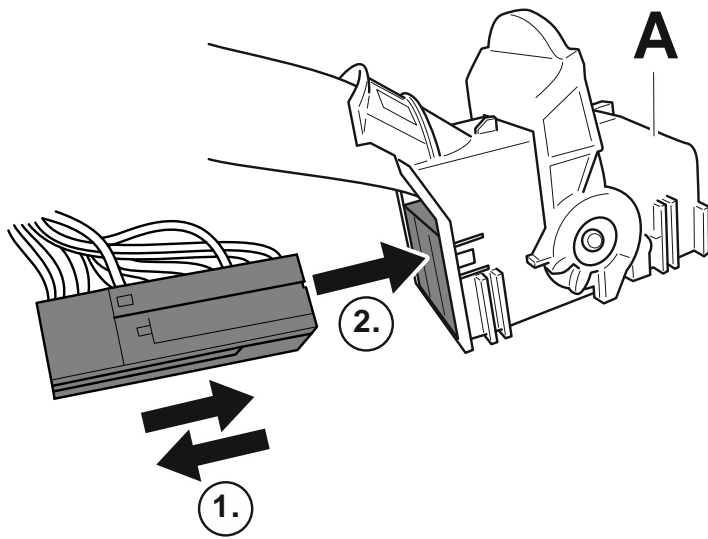

21

**BCM**

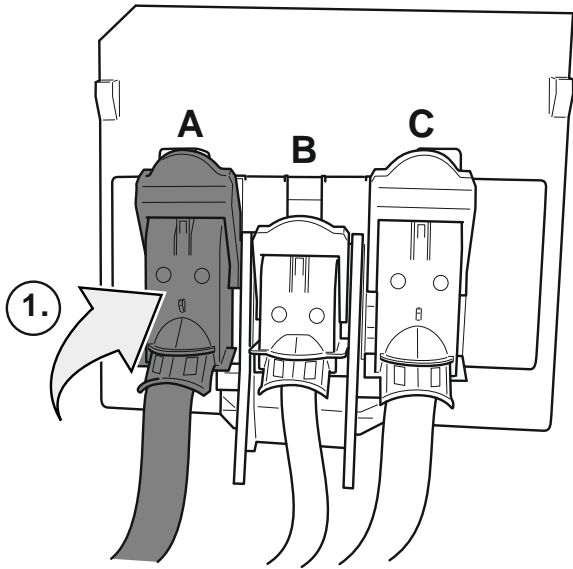

**BCM**

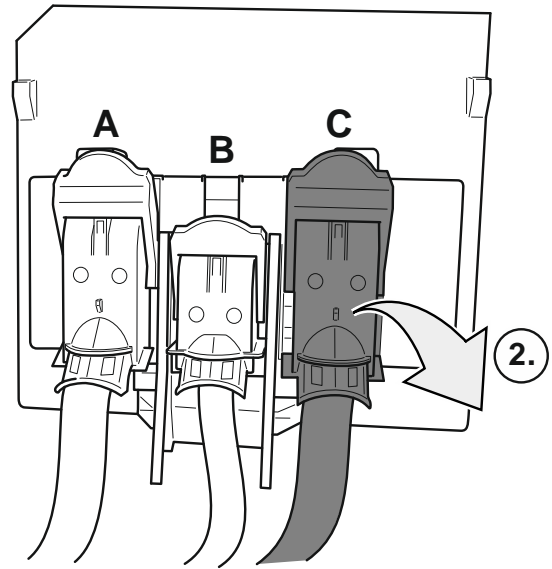

22

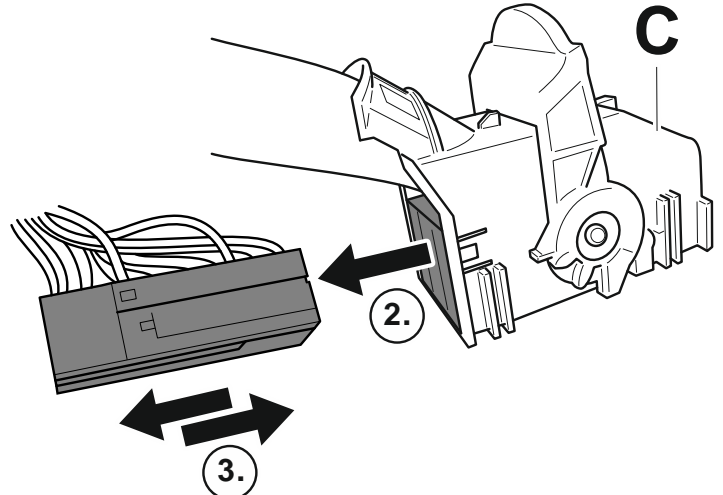
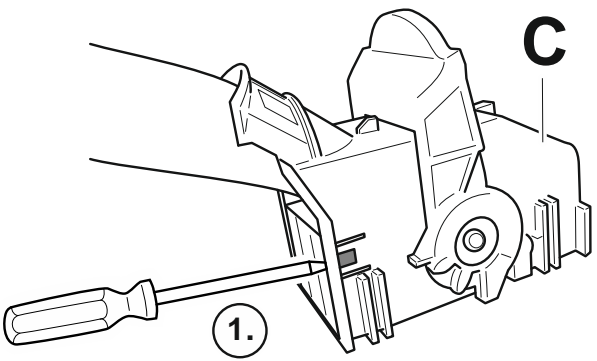

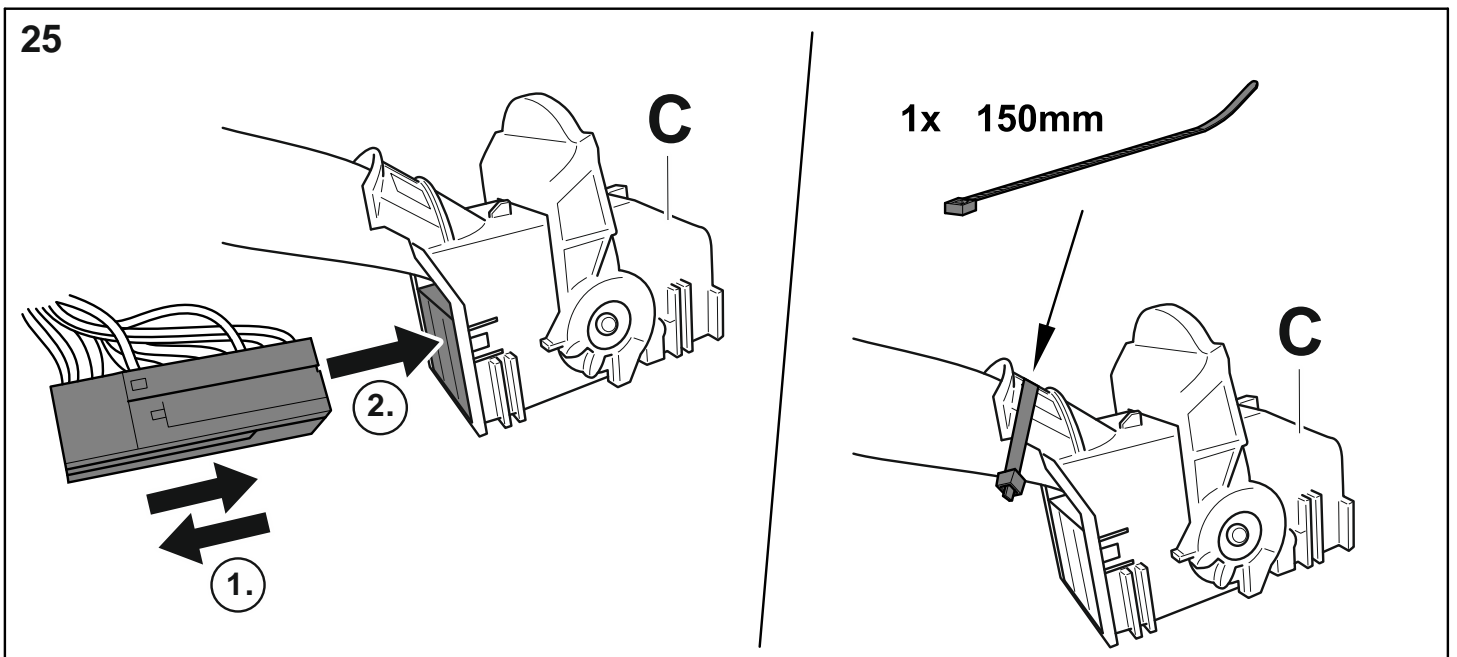
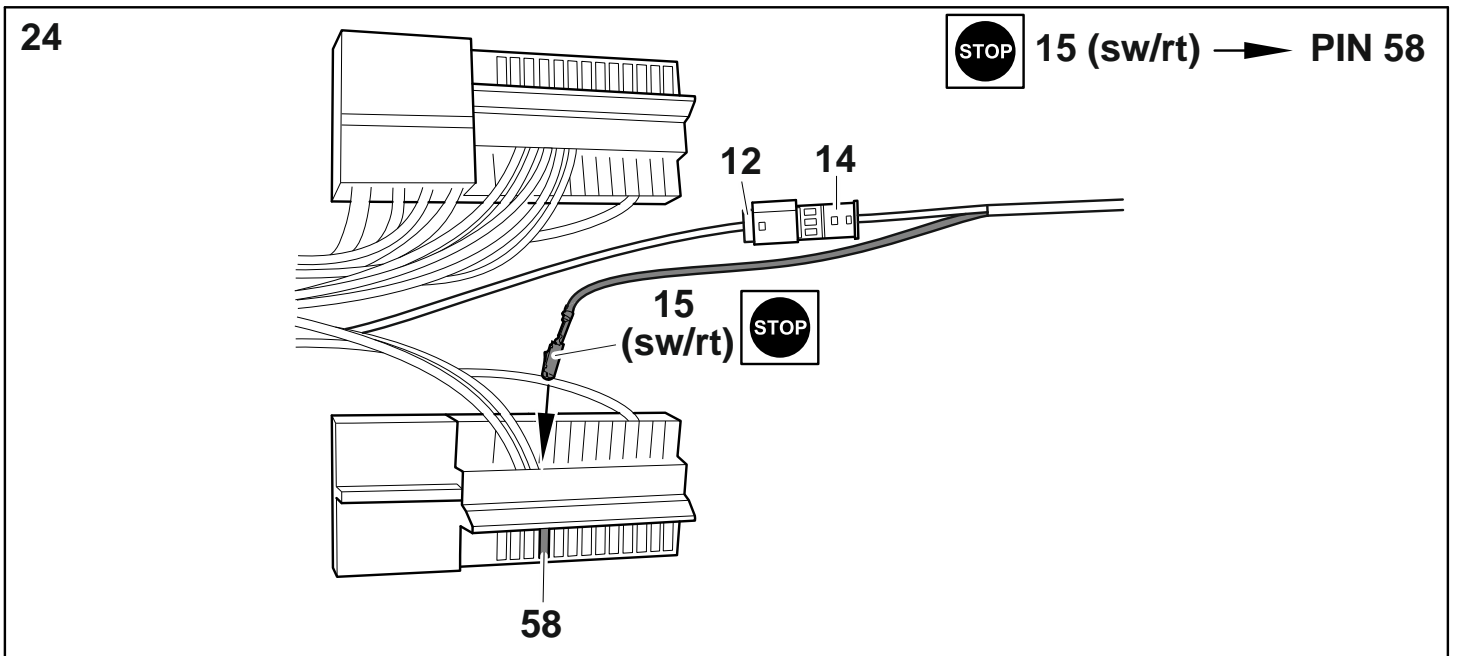
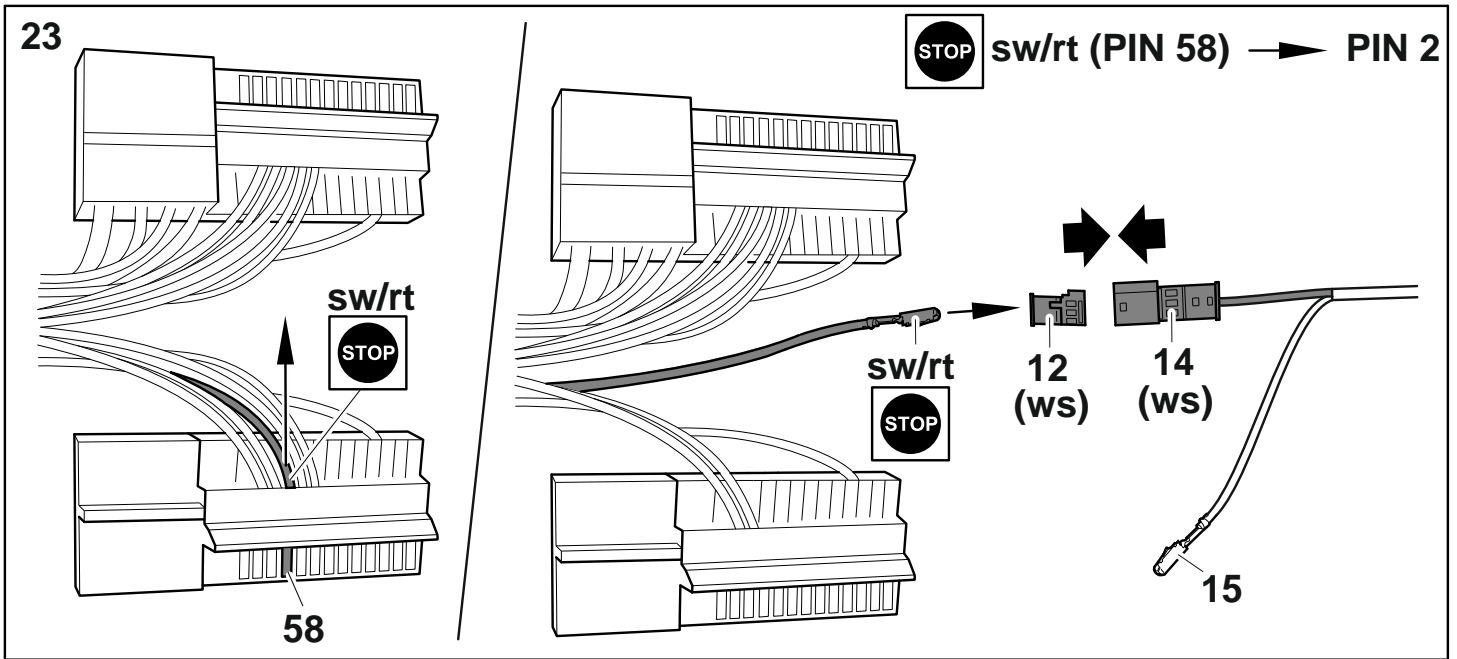



26

# BCM

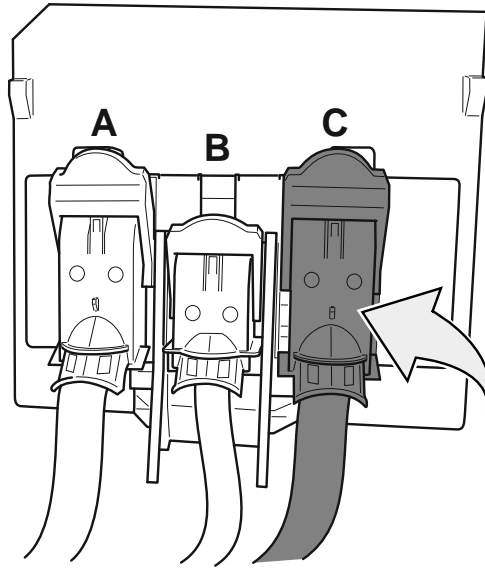

27

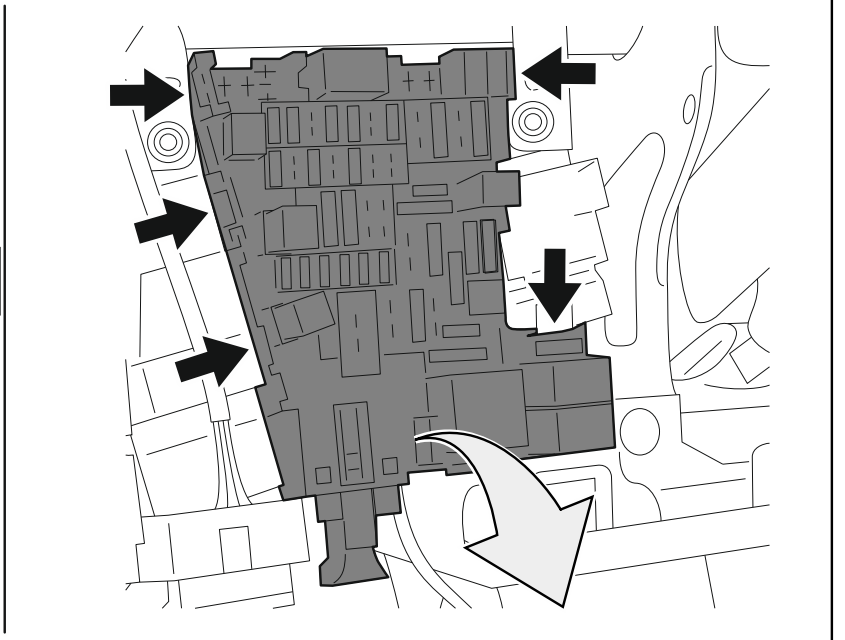
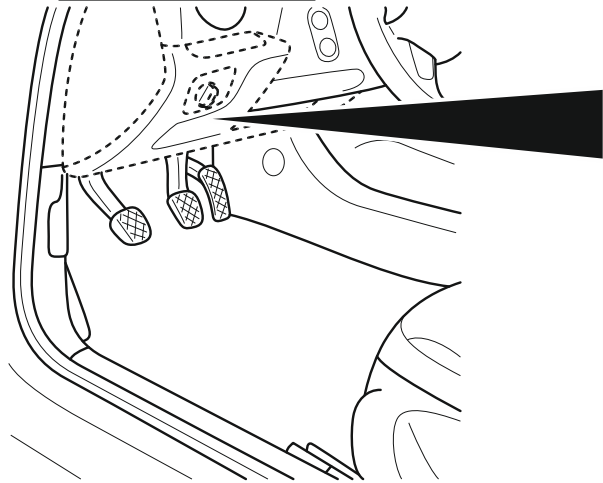
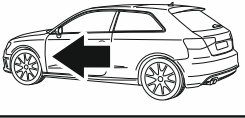

28

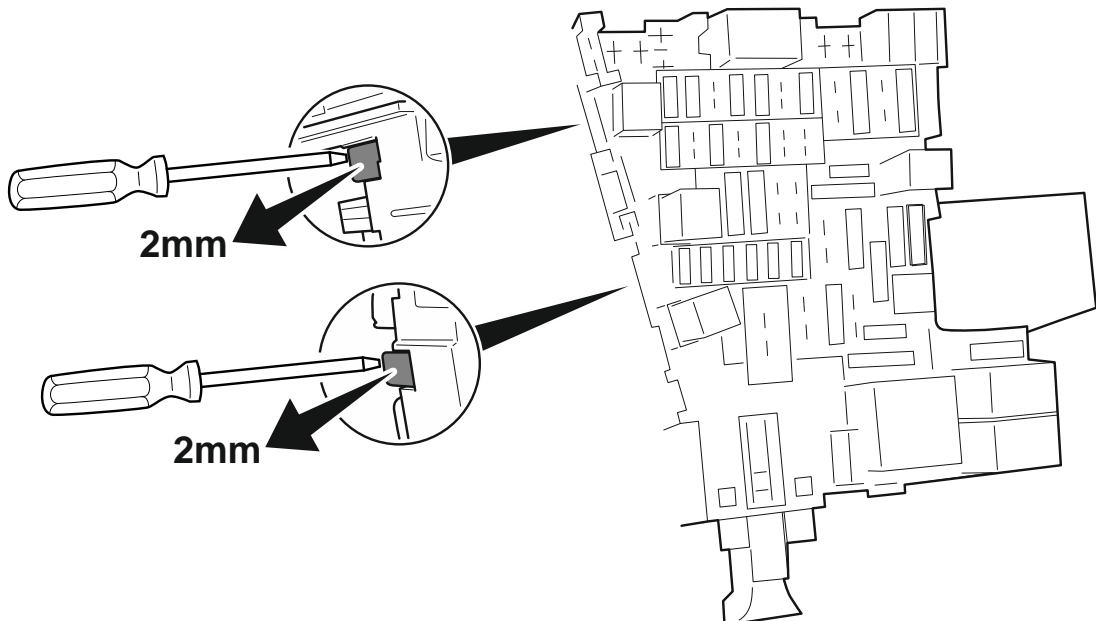

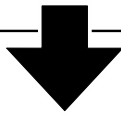
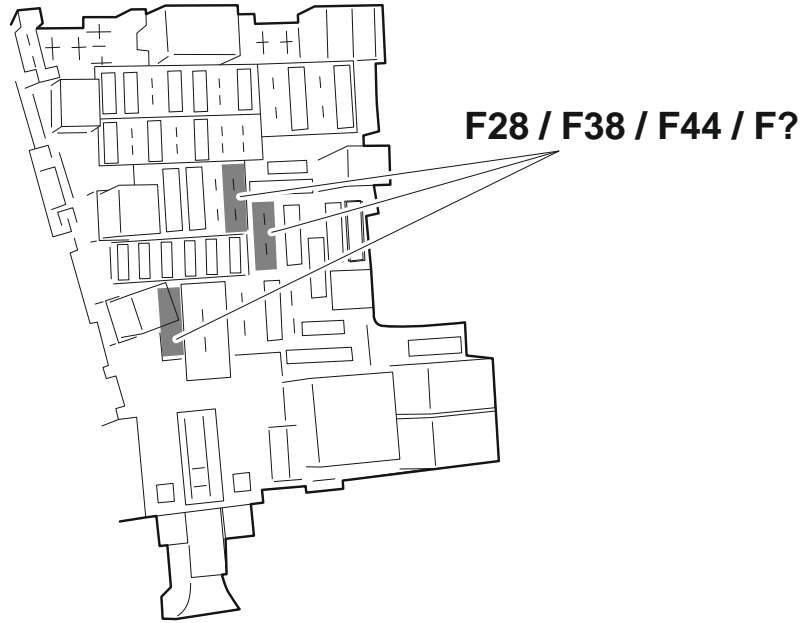

**VW**  
**Seat**  
**Cupra**  
**Skoda**

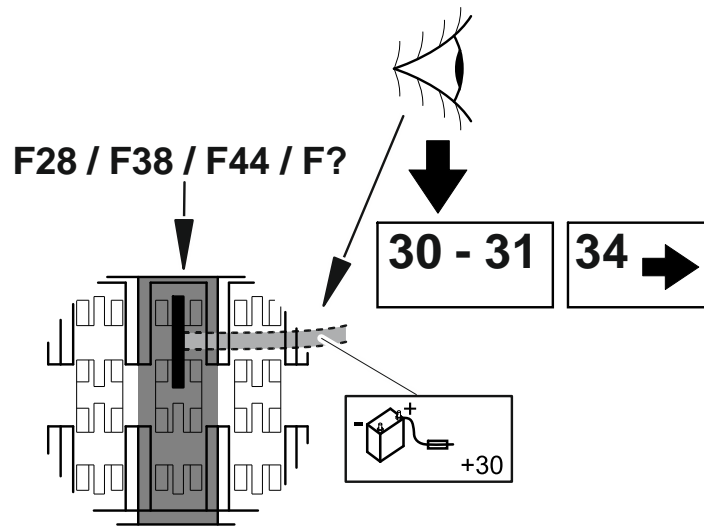

30 **VW  
Seat  
Cupra  
Skoda**

7p/13p

24 — 25A

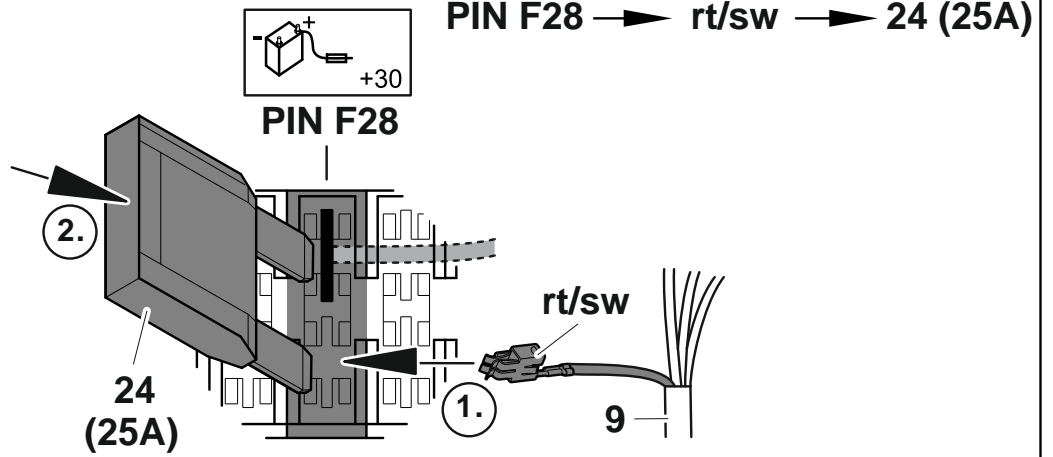

7p/13p

24 — 25A

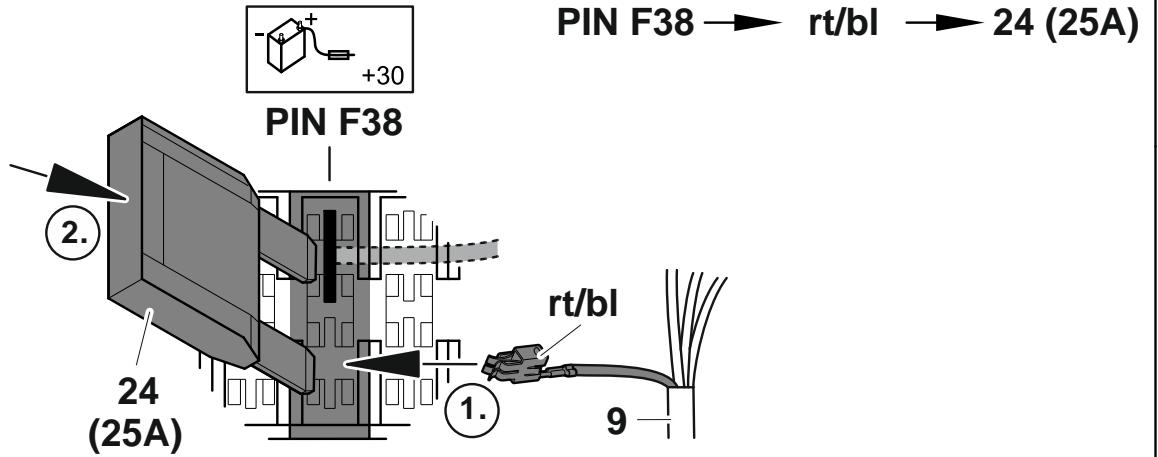

13p

25 — 15A

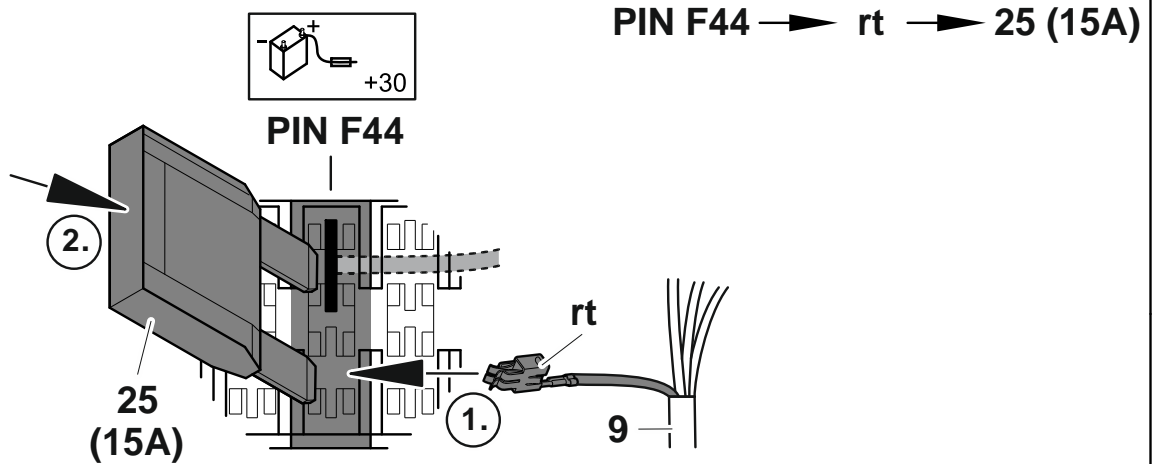

13p

25 — 15A

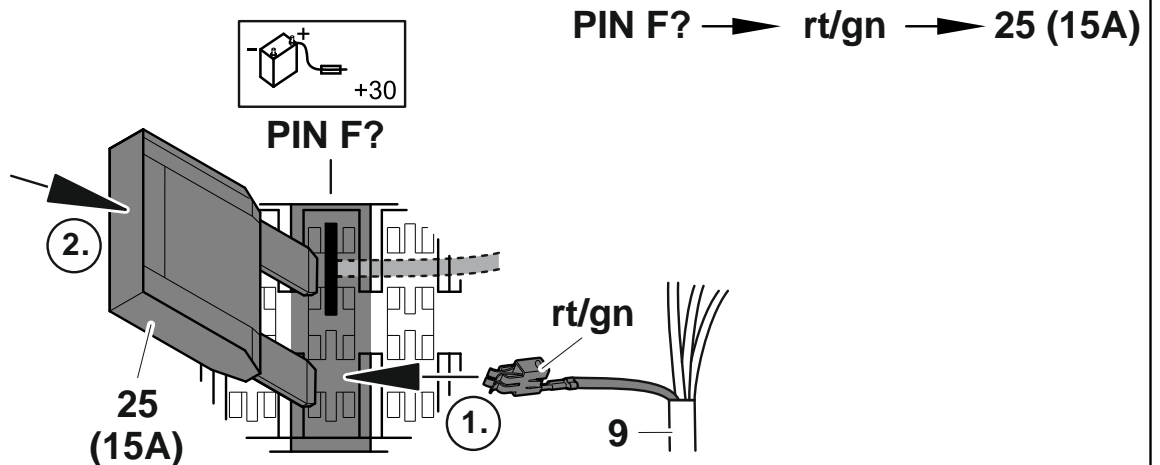

31

# VW Seat Cupra Skoda

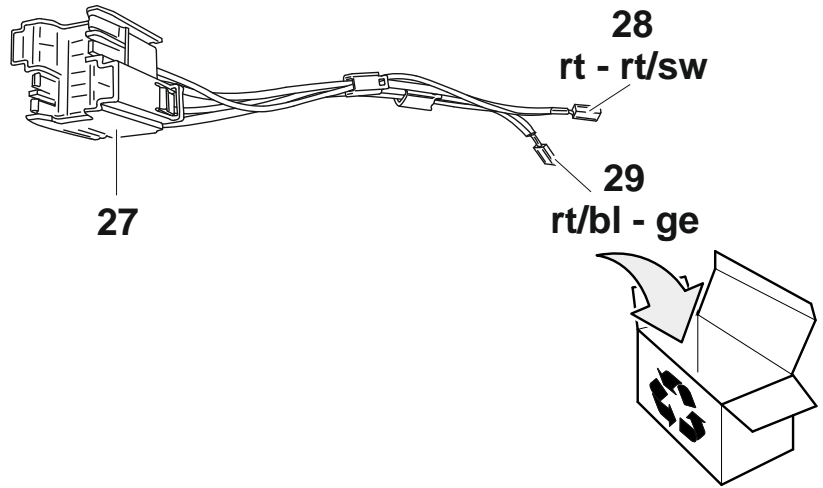

32a

# Audi A3 Audi Q2, →2019

- (7p/13p) PIN 1 → rt/sw → 25A
- (13p) PIN 2 → rt → 15A
- (7p/13p) PIN 3 → rt/bl → 25A
- (13p) PIN 4 → rt/gn → 15A

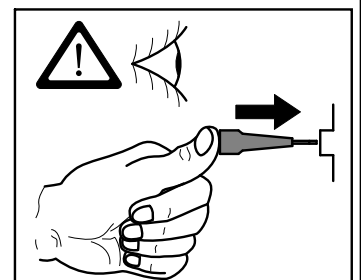
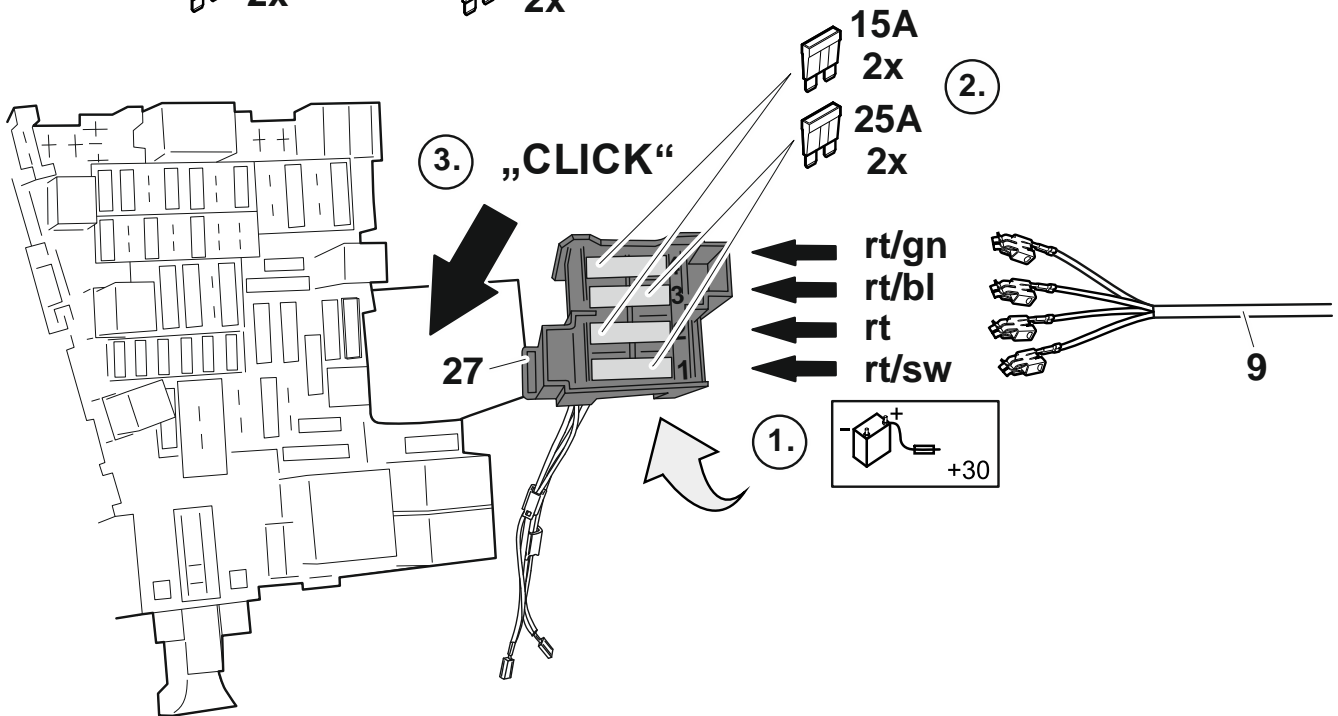
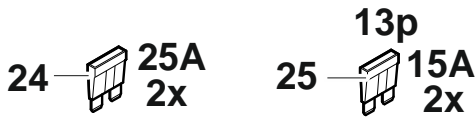

**32b Audi Q3  
Audi Q3 Sportback  
Audi Q2, FL 2020→**

(7p/13p) PIN 1 → rt/sw → 25A  
 (13p) PIN 2 → rt → 15A  
 (7p/13p) PIN 3 → rt/bl → 25A  
 (13p) PIN 4 → rt/gn → 15A

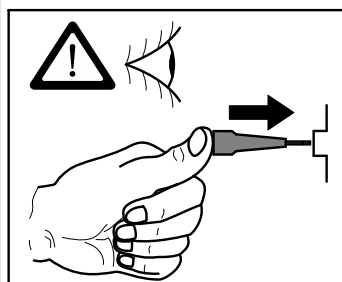
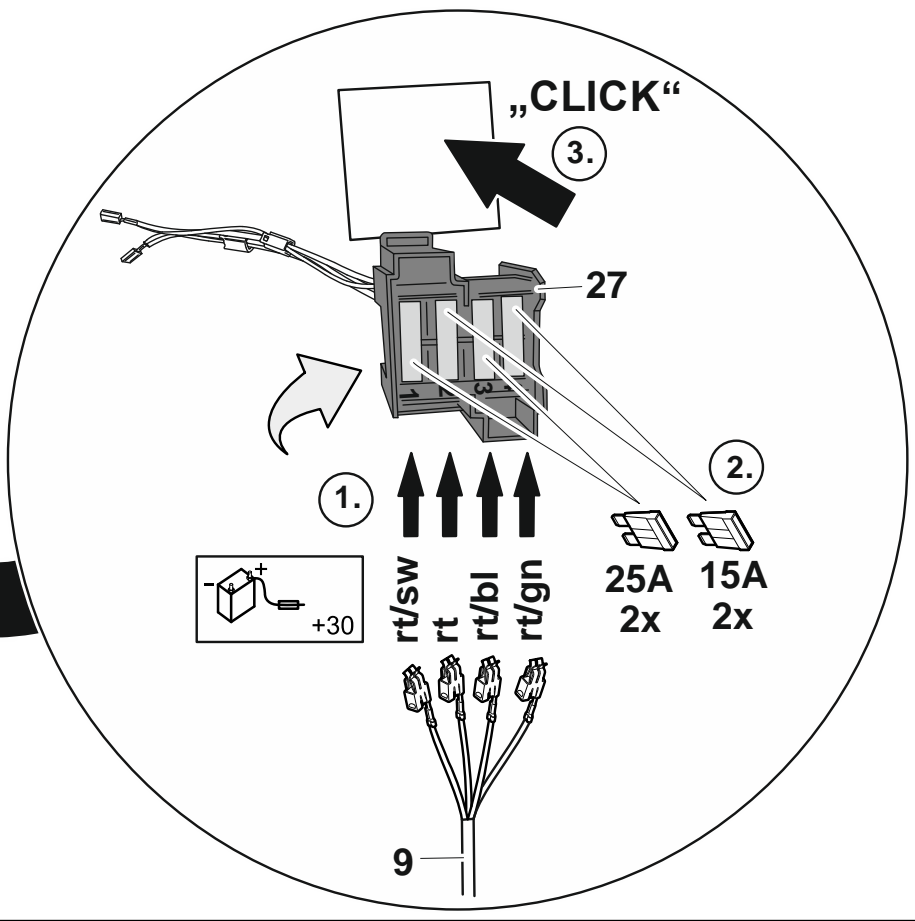

**33a Audi A3  
Audi Q2, →2019**

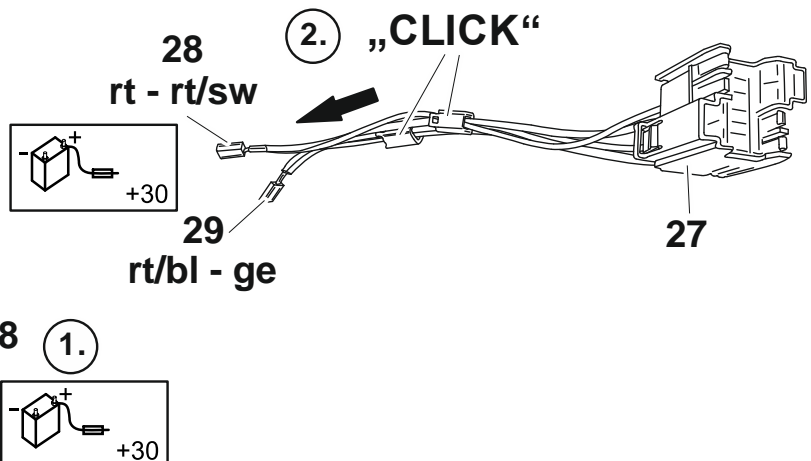
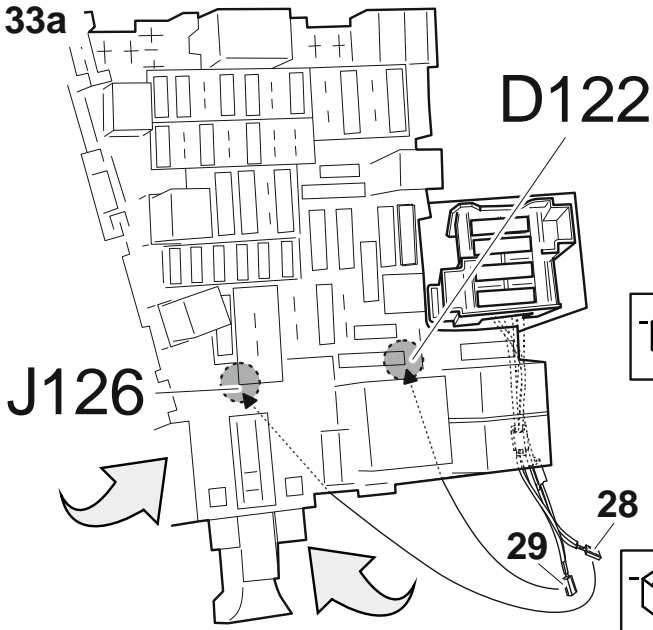

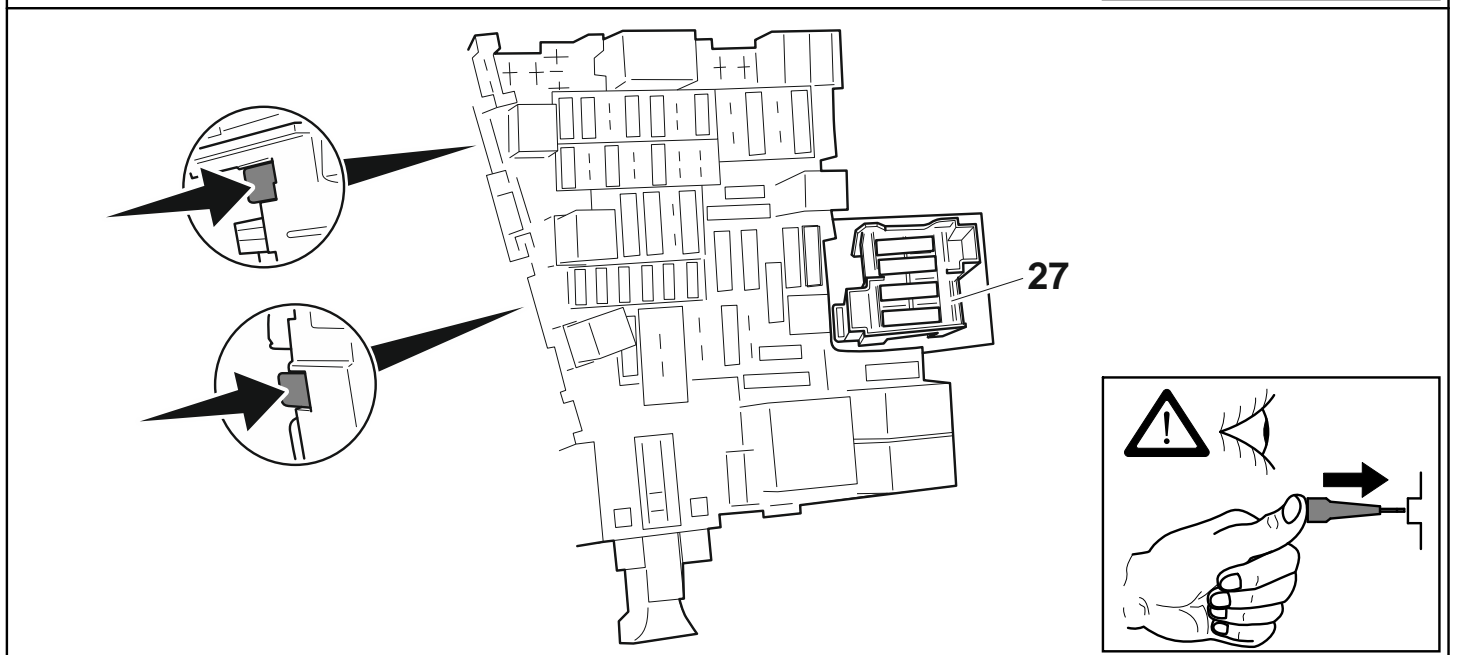
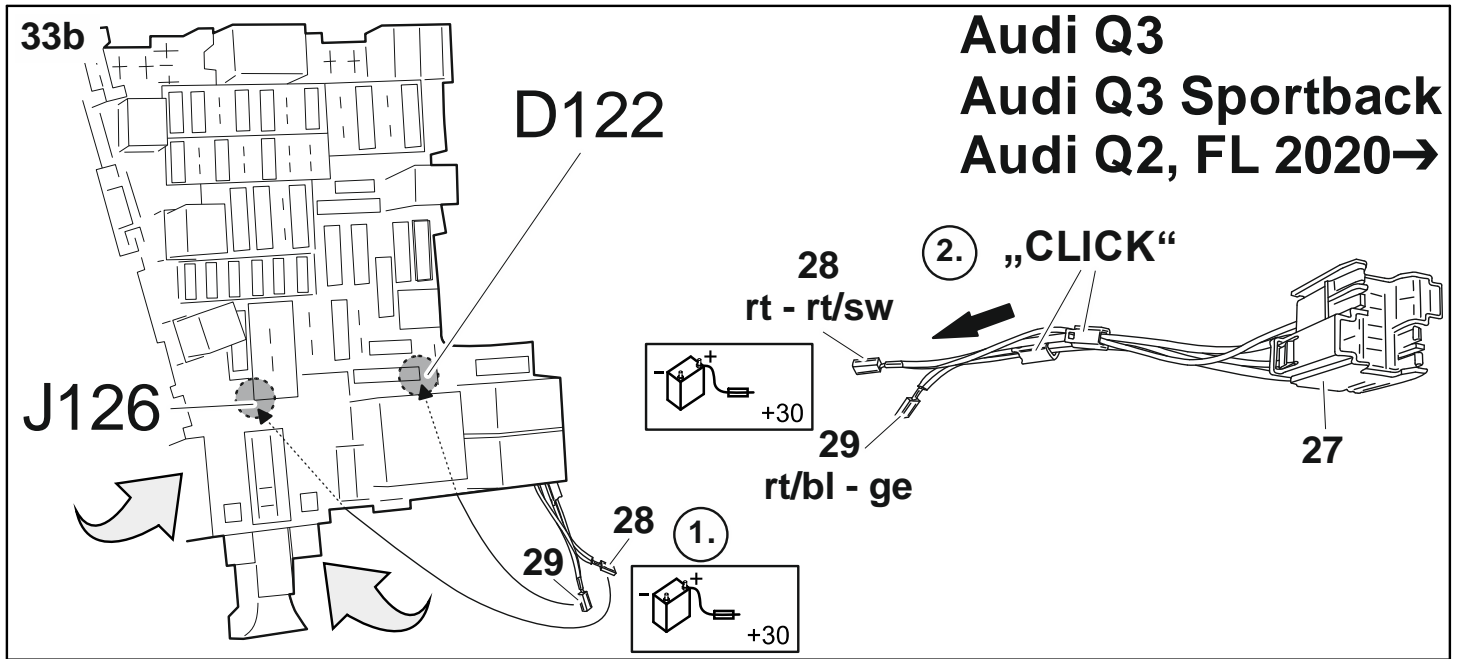



35

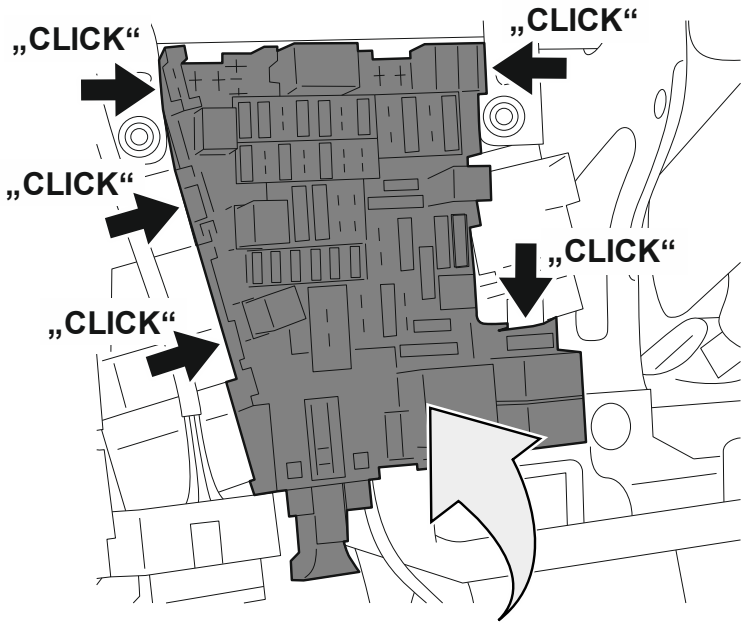

36

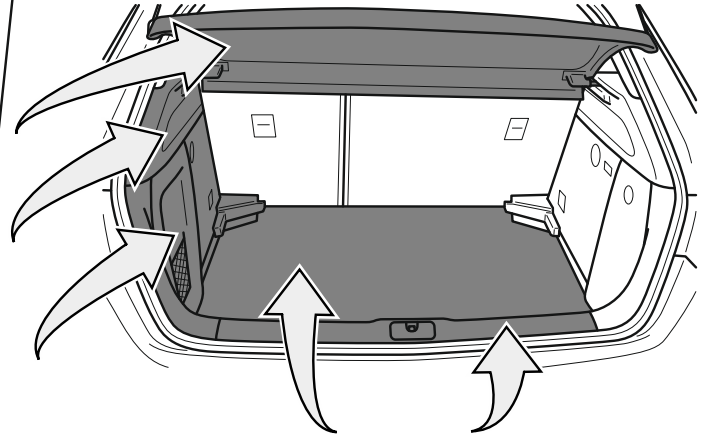
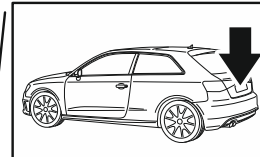
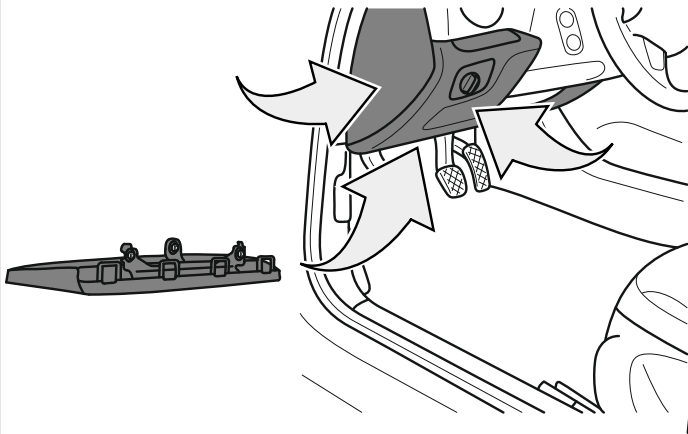

37

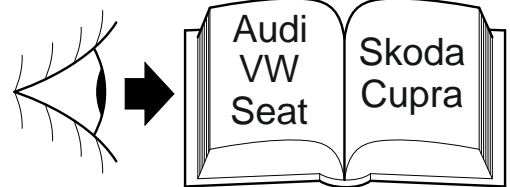
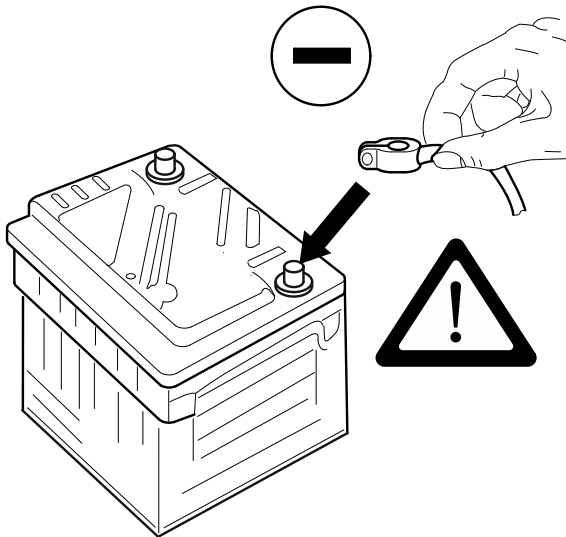

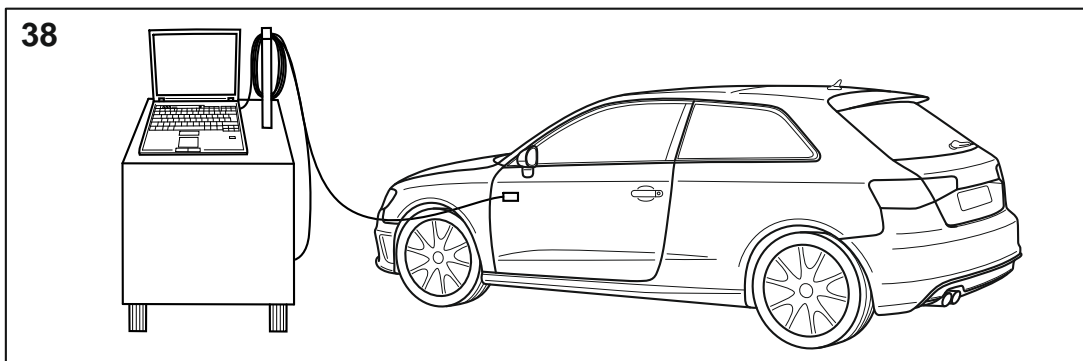

**D**

#### **Wichtige Hinweise!**

Das Fahrzeug benötigt eine korrekt und vollständig durchgeführte Kodierung, die nicht im Liefer- und Leistungsumfang enthalten und von Ihnen eigenverantwortlich durchzuführen ist. Ohne diese Fahrzeugkodierung ist unter anderem eine fehlerfreie Unterstützung der Fahrassistenzsysteme nicht immer möglich. Eine Online Kodierung des Fahrzeugs über den jeweiligen Fahrzeug-Vertragshändler ist ohne Maßnahmen- oder SVM Code nicht möglich. Der Maßnahmen- oder SVM Code ist nicht im Lieferumfang enthalten oder bei Westfalia Automotive erhältlich. Fahrzeuge können unter Verwendung von Diagnosetools diverser Diagnosedienstleister alternativ „Offline“ kodiert werden. Bitte hierfür immer die aktuellste Diagnoseversion verwenden! Das zu kodierende Fahrzeug muss vom Diagnosetool unterstützt werden und muss bereits in der Diagnoseversion implementiert sein! Bitte wenden Sie sich bei Fragen bzgl. der Kodierung direkt an den von Ihnen gewählten Diagnosedienstleister. Nachfolgend finden Sie eine kleine Auswahl von Diagnosedienstleistern und / -tools, die nach unserer Kenntnis individuelle Lösungen für Kodierungen auf Anhängerbetrieb anbieten (lokal / offline). Diese kleine Auswahl stellt keine Empfehlung dar. Gewähr und Verantwortung für den von Ihnen gewählten Diagnosedienstleister und dessen Diagnosetool übernehmen wir nicht.

**E**

#### **Indicaciones importantes!**

El vehículo requiere una codificación correcta y completa, que no está incluida en el volumen de suministro y servicios y debe ser realizada por usted bajo su propia responsabilidad. Sin esta codificación del vehículo no siempre es posible, entre otras cosas, el apoyo sin fallos de los sistemas de asistencia a la conducción. Sin el código action o SVM no es posible la codificación online del vehículo a través del concesionario autorizado correspondiente. El código action o SVM no se incluye en el volumen de suministro ni está disponible en Westfalia Automotive. Como alternativa, los vehículos pueden codificarse "offline" con herramientas de diagnóstico de diferentes proveedores de servicios de diagnóstico. Por favor, utilice siempre la última versión de diagnóstico. El vehículo a codificar debe ser soportado por la herramienta de diagnóstico y debe estar ya implementado en la versión de diagnóstico. Si tiene alguna pregunta sobre la codificación, póngase en contacto directamente con el proveedor de servicios de diagnóstico que haya elegido. A continuación encontrará una pequeña selección de proveedores de servicios de diagnóstico y / herramientas que, a nuestro conocimiento, ofrecen soluciones individuales para la codificación en el funcionamiento del remolque (local / offline). Esta pequeña selección no representa una recomendación. No asumimos ninguna garantía ni responsabilidad por el proveedor de servicios de diagnóstico que haya elegido y su herramienta de diagnóstico.

**F**

#### **Remarques importantes !**

Le véhicule nécessite un codage correct et complet qui n'est pas compris dans la livraison et les prestations et que vous devez effectuer sous votre propre responsabilité. Sans ce codage du véhicule, il n'est pas toujours possible, entre autres, de prendre en charge sans erreur les systèmes d'assistance à la conduite. Un codage en ligne du véhicule par le biais du concessionnaire automobile concerné n'est pas possible sans code de mesure ou code SVM. Le code de mesure ou le code SVM n'est pas compris dans la livraison ou disponible chez Westfalia Automotive. Les véhicules peuvent être codés "hors ligne" en utilisant les outils de diagnostic de divers prestataires de services de diagnostic. Veuillez toujours utiliser la version de diagnostic la plus récente ! Le véhicule à coder doit être pris en charge par l'outil de diagnostic et doit déjà être implémenté dans la version de diagnostic ! Pour toute question concernant le codage, veuillez vous adresser directement au prestataire de services de diagnostic que vous avez choisi. Vous trouverez ci-dessous une petite sélection de prestataires de services de diagnostic et / ou d'outils qui, à notre connaissance, proposent des solutions individuelles pour le codage en mode remorque (local / hors ligne). Cette petite sélection ne constitue pas une recommandation. Nous n'assumons aucune garantie ni responsabilité pour le prestataire de services de diagnostic et son outil de diagnostic que vous avez choisis.

**GB**

#### **Important notes!**

The vehicle requires full vehicle coding which is not included in the product provided and has to be done by you independently. Without vehicle coding an error free support of all advanced driver assist systems will not always be possible. Online coding of the vehicle via the relevant vehicle manufacturer's authorised dealer is not possible without an action or SVM code. The action or SVM code is not included with the product and cannot be purchased from Westfalia-Automotive. Vehicles can be coded ,offline' by using diagnostic tools from various diagnostics service providers. This requires always the latest version of the diagnostic tool. The diagnostic tool has to support the vehicle that is to be coded and has to be available as an option of the diagnostic version used. Please contact your chosen diagnostics service provider if you have any questions. Please find below a small selection of diagnostics service providers and tools that are offering coding solutions for towing according to our knowledge. This selection is not a recommendation. We do not accept any liability and responsibility for your chosen diagnostics service provider and their diagnostics tool.







**I**

#### **Note importanti!**

Il veicolo necessita di una codifica corretta e completa, che non è inclusa nella fornitura e nei servizi e deve essere eseguita dall'utente sotto la propria responsabilità. Senza questa codifica del veicolo, non è sempre possibile un supporto privo di errori, tra l'altro, dei sistemi di assistenza alla guida. La codifica online del veicolo tramite il rispettivo rivenditore autorizzato non è possibile senza il codice azione o SVM. Il codice azione o SVM non è incluso nella fornitura o disponibile presso Westfalia Automotive. In alternativa, i veicoli possono essere codificati "offline" utilizzando strumenti diagnostici di vari fornitori di servizi diagnostici. A tale scopo, utilizzare sempre la versione diagnostica più recente! Il veicolo da codificare deve essere supportato dallo strumento di diagnosi e deve essere già implementato nella versione di diagnosi! In caso di domande sulla codifica, si prega di contattare direttamente il fornitore di servizi diagnostici prescelto. Di seguito troverete una piccola selezione di fornitori di servizi diagnostici e / strumenti che, a nostra conoscenza, offrono soluzioni individuali per la codifica sul funzionamento del rimorchio (locale / offline). Questa piccola selezione non rappresenta una raccomandazione. Non ci assumiamo alcuna garanzia o responsabilità per il fornitore di servizi diagnostici scelto e per il relativo strumento diagnostico.

**NL****Belangrijke opmerkingen!**

Het voertuig vereist een correcte en volledige codering, die niet bij de levering en service is inbegrepen en door u op eigen verantwoordelijkheid moet worden uitgevoerd. Zonder deze voertuigcodering is een storingsvrije ondersteuning van onder andere de rijkhulpsystemen niet altijd mogelijk. Zonder de actie- of SVM-code is online codering van het voertuig via de betreffende erkende voertuighandelaar niet mogelijk. De actie- of SVM-code is niet bij de levering inbegrepen of bij Westfalia Automotive verkrijgbaar. Voertuigen kunnen ook "offline" met diagnosetools van verschillende aanbieders van diagnoseservices worden gecodeerd. Gebruik hiervoor altijd de nieuwste diagnoseversie! Het te coderen voertuig moet door de diagnosetool worden ondersteund en reeds in de diagnoseversie zijn geïmplementeerd! Als u vragen hebt over de codering, neem dan rechtstreeks contact op met de door u gekozen aanbieder van diagnostische diensten. Hieronder vindt u een kleine selectie van diagnostische dienstverleners en / tools die, voor zover wij weten, individuele oplossingen bieden voor codering op aanhangwagengebruik (lokaal / offline). Deze kleine selectie is geen aanbeveling. Wij aanvaarden geen enkele garantie of verantwoordelijkheid voor de door u gekozen dienstverlener en zijn diagnosegereedheid.

<b>D</b>	<b>Diagnosedienstleister und -tools</b>	<b>Ergänzende Hinweise und Hilfestellungen</b>
<b>E</b>	<b>Proveedores de servicios y herramientas de diagnóstico</b>	<b>Información complementaria y asistencia</b>
<b>F</b>	<b>Prestataires de services et outils de diagnostic</b>	<b>Remarques et aides complémentaires</b>
<b>GB</b>	<b>Diagnostic service providers and tools</b>	<b>Supplementary notes and assistance</b>
<b>I</b>	<b>Fornitori di servizi e strumenti di diagnosi</b>	<b>Informazioni e assistenza supplementari</b>
<b>NL</b>	<b>Diagnostische dienstverleners en hulpmiddelen</b>	<b>Aanvullende informatie en bijstand</b>
Westfalia Autocode / Autocode Mini		<a href="https://diagup.me/Westfalia-support">diagup.me/Westfalia-support</a>
	<a href="https://www.westfalia-automotive.com/de/produkte/fahrzeugcodierung/">https://www.westfalia-automotive.com/de/produkte/fahrzeugcodierung/</a>	
Westfalia Autocode-Remote		<a href="https://www.westfalia-automotive.com/de/produkte/fahrzeugcodierung/autocode-remote/">https://www.westfalia-automotive.com/de/produkte/fahrzeugcodierung/autocode-remote/</a>
Jifeline	<a href="https://www.jifeline.help/de/ferndiagnose-leistungen">https://www.jifeline.help/de/ferndiagnose-leistungen</a>	
VCDS		<a href="https://wiki.vcde.de/index.php/Nachrüstungen">https://wiki.vcde.de/index.php/Nachrüstungen</a>
	<a href="https://www.vcde.de/fileadmin/DownloadCenter/Anleitungen/Nachruestung_AHK.pdf">https://www.vcde.de/fileadmin/DownloadCenter/Anleitungen/Nachruestung_AHK.pdf</a>	
HELLA GUTMANN SOLUTIONS		<a href="https://www.hella-gutmann.com/de/macsrremoteservices-info">https://www.hella-gutmann.com/de/macsrremoteservices-info</a>

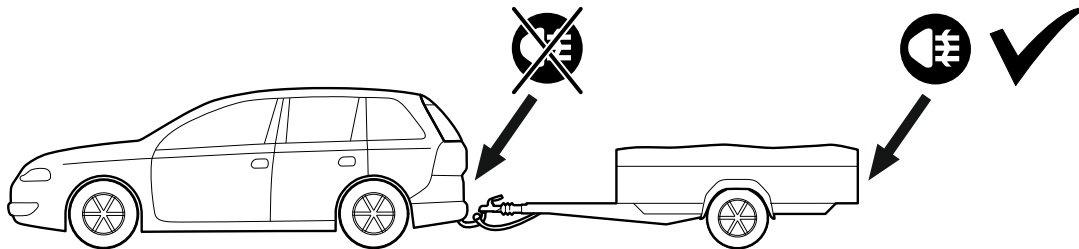

- D** Bei Anhängerbetrieb wird die Nebelschlussleuchte des Zugfahrzeugs abgeschaltet.
- E** Al circular con remolque se desconecta la luz antiniebla trasera del vehículo de tiro.
- F** Lorsqu'une remorque/caravane est attelée, le fonctionnement du feu de brouillard arrière du véhicule tracteur est interrompu.
- GB** When towing a trailer, the rear fog light of the pulling vehicle is switched off.
- I** Durante il funzionamento con rimorchio la luce antinebbia posteriore della motrice viene spenta.
- NL** Bij gebruik van de aanhanger wordt het mistachterlicht van het voertuig uitgeschakeld.

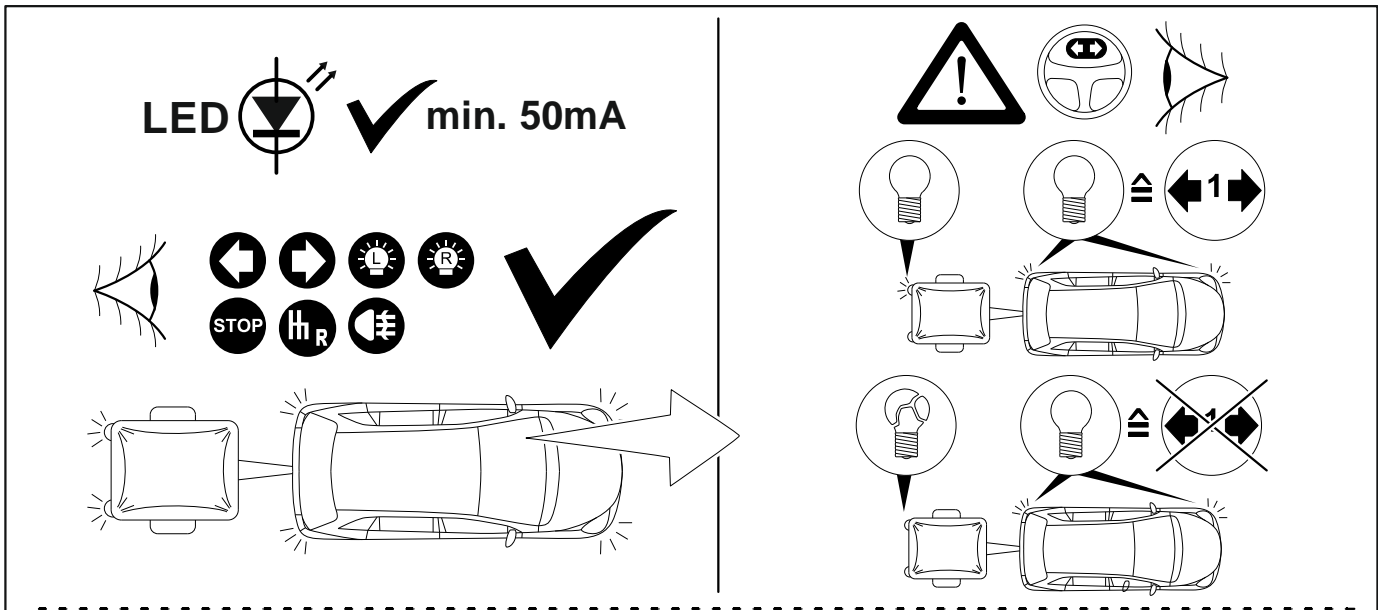
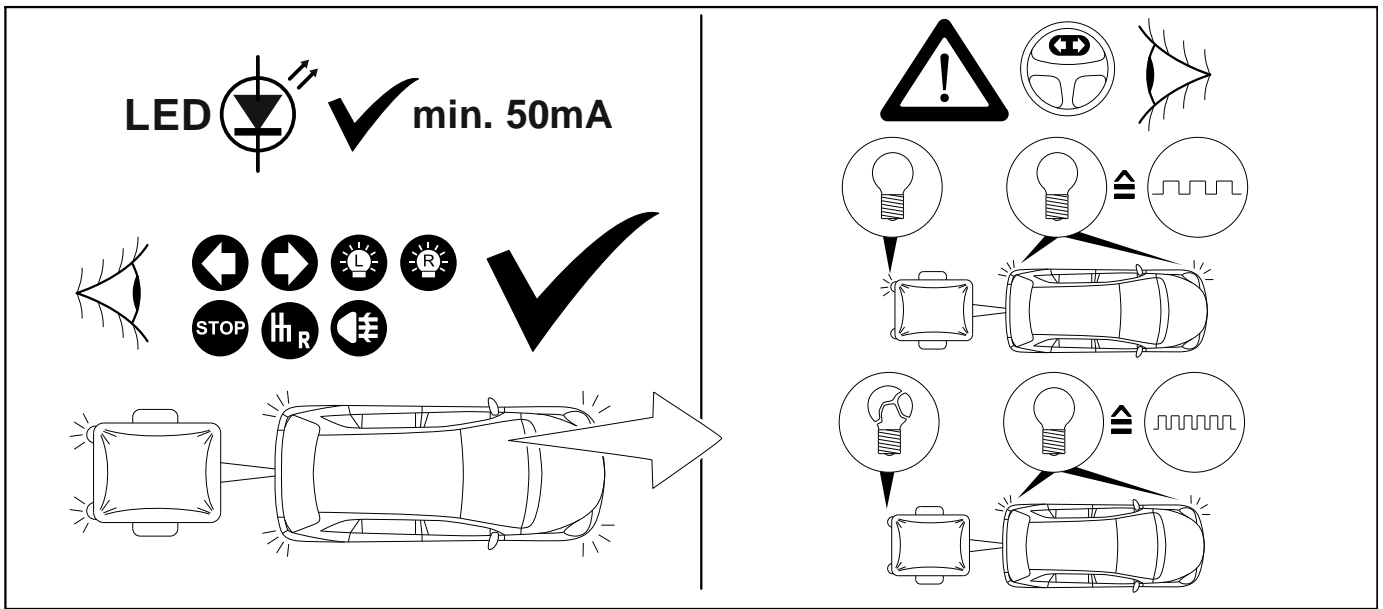

**westfalia**  
AUTOMOTIVE

**Testkoffer für Lichttest**  
Trailer simulation for light-check  
7-pin und/and 13-pin  
WA nr.: 900 001 300 198

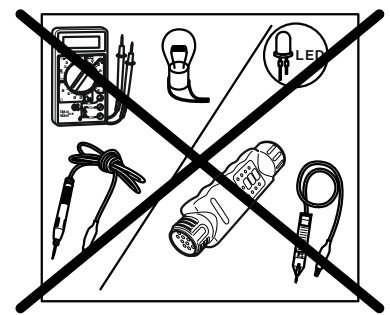

- D** Beschränken Sie bei Funktionsproblemen die Fehlersuche auf ca. 30 Minuten und kontaktieren Sie dann den Kundendienst.
- E** En caso de problemas funcionales, limite la solución de problemas a aproximadamente 30 minutos y a continuación, póngase en contacto con el servicio al cliente.
- F** En cas de problèmes fonctionnels, limitez le dépannage à environ 30 minutes et puis contactez le service client.
- GB** In case of functional problems, limit troubleshooting to about 30 minutes and then contact customer service.
- I** In caso di problemi funzionali, limitare la risoluzione dei problemi a circa 30 minuti e quindi contattare il servizio clienti.
- NL** Beperk bij functiestoringen het verhelpen van storingen tot ca. 30 minuten en neem dan contact op met de klantenservice.

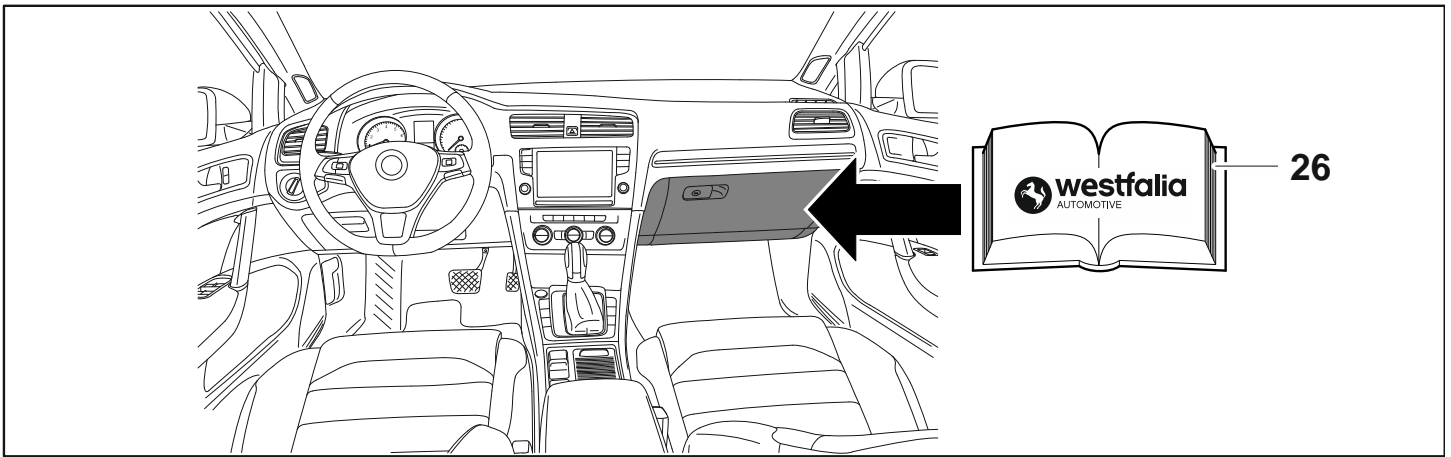

Optional:  
Steckdosenadapter  
adapter socket

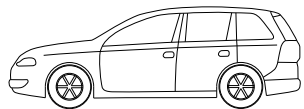

13-pin



7-pin

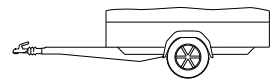

WA nr.: 300 100 320 113

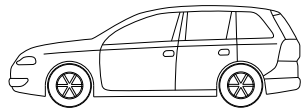

7-pin

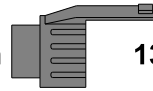

13-pin

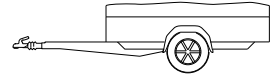

WA nr.: 300 100 310 107

7p

WA nr.

900 001 506 424

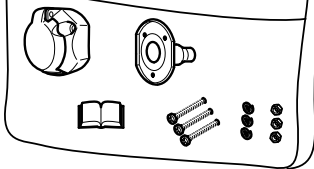

13p

WA nr.

900 001 506 607

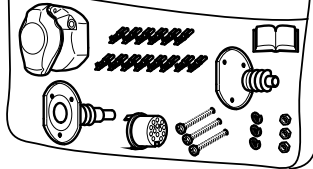

WA nr.

900 001 507 014

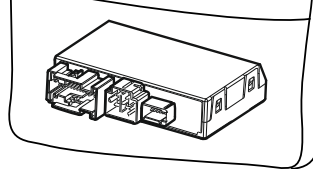

WA nr.

900 001 503 924

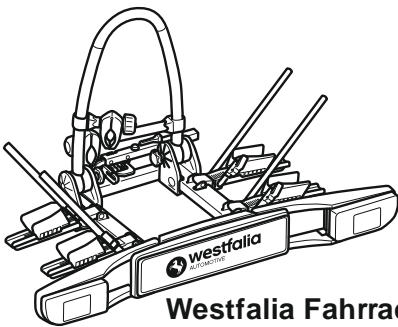
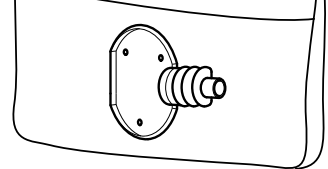

Westfalia Fahrradträger  
Westfalia Cycle Carrier  
WA nr.: 350 050 600 001

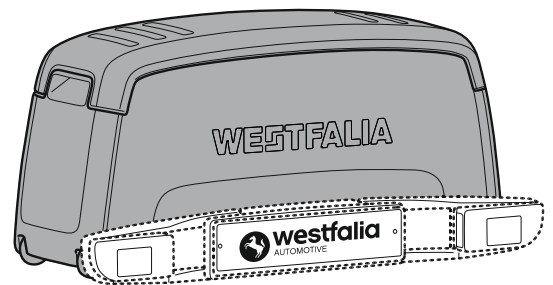

Box  
WA nr.: 350 002 600 001