



# Kits with camshaft cover

Technical Bulletin - September 2010



Audi, Skoda, Volkswagen



**KIT INFORMATION - Mandatory Replacement of camshaft cover**



VKMA 01951 - VKMA 01952

VKMA 01151 - VKMA 01152

VKMC 01951 - VKMC 01952

CAR MAKER	MODEL	ENGINE	ENGINE CODES
Audi	A4, A6, A8, Allroad	2,5 TDI	BCZ, BDG, BFC
Skoda	Superb	2,5 TDI	BDG
Volkswagen	Passat	2,5 TDI	AFB, AKN, BAU, BDG, BDH

In line with SKF's philosophy to offer a complete repair solution for the installer, and to be in line with OE recommendation, SKF has included camshaft cover in the kits above.

To fit the camshaft timing tool during the timing belt kit replacement, you have to remove the camshaft cover. However, the cap is not re-usable due to material deterioration. The camshaft cover plays an important role, as it is designed to prevent oil leakage.







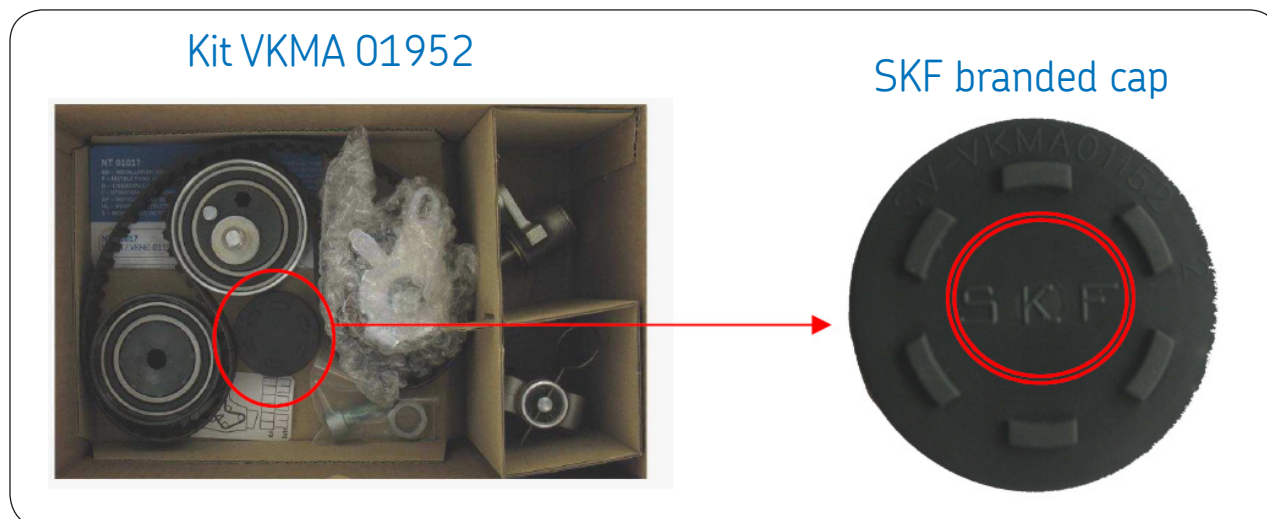



It is mandatory to replace the camshaft cover as it has a sealing function for the camshafts.

For a complete and a professional repair, the camshaft cover is included in the following kits:  
 VKMA 01951 - VKMA 01952 / VKMA 01151 – 01152 / VKMC 01951 -VKMC 01952



Kits composition:

									
VKMA 01951	2	1	2	1			1	3	T0166
VKMA 01952	2	1	2	1			1	3	T0170
VKMA 01151	2	1	2				1	2	T0166
VKMA 01152	2	1	2				1	2	T0170
VKMC 01951	2	1	2	1	1		1	3	T0166
VKMC 01952	2	1	2	1	1		1	3	T0170

To refit the camshaft cover (12 on the picture below), don't hesitate to consult the step 10 in the specific fitting instruction included in the kits:

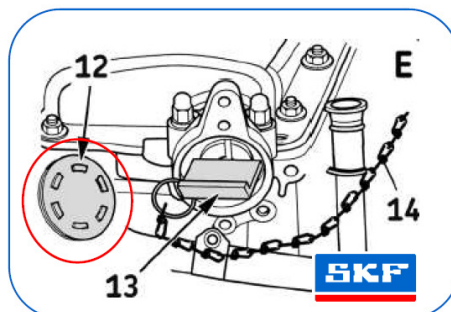
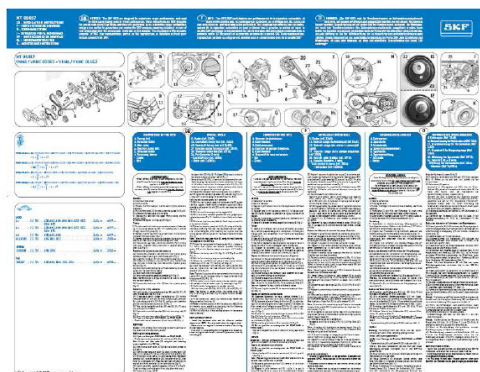

© SKF is a registered trademark of the SKF Group.

© SKF Group 2010  
 The contents of this publication are the copyright of the publisher and may not be reproduced (even extracts) unless prior written permission is granted. Every care has been taken to ensure the accuracy of the information contained in this publication but no liability can be accepted for any loss or damage whether direct, indirect or consequential arising out of the use of the information contained herein.

