

ZF Aftermarket Service Information

Replacing air spring
BMW
E70 E71 F15 F16

Manufacturer BMW

Product

Document number 40935 EN



AFTERMARKET

LEMFÖRDER  SACHS  TRW



1 Replacing air spring

Vehicle manufacturers	Model range	Model
BMW	E70 F15	X5
	E71 F16	X6

Tab. 1

 Vehicle identification: Check OE item number.

Storing air springs	
Temperature	-15°C (min.) / +50°C (max.)
UV radiation	Avoid direct sunlight.
Storage environment	Ensure a clean storage environment. Avoid contamination.

Tab. 2 Storing air springs

1.1 Removing air spring, rear axle

Requirements:

- Vehicle has been raised safely.
- Air suspension has been emptied using suitable diagnostic unit. Observe the vehicle manufacturer specifications.
- Wheel has been removed.

CAUTION

**Risk of injury due to flying parts.
Slight to moderate injury possible.**

- ⇒ Wear protective goggles.
- ⇒ Wear hearing protection.
- ⇒ Wear protective gloves.



1. Loosen the safety latches at the bottom anchoring of the air spring by squeezing them together.

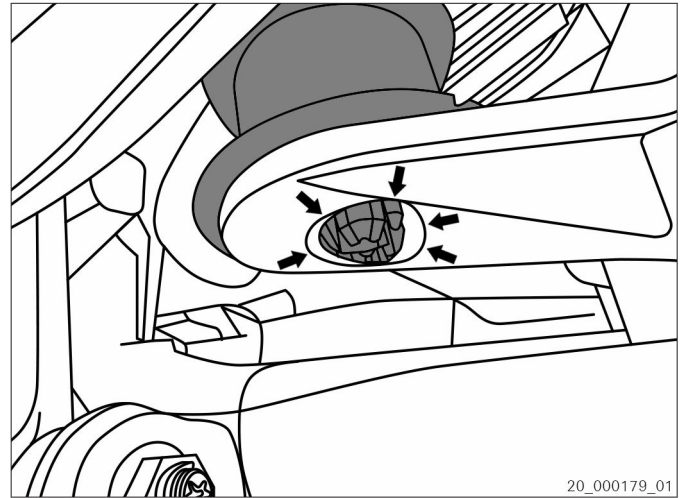

Fig. 1

2. Push air spring out of the bottom anchoring.

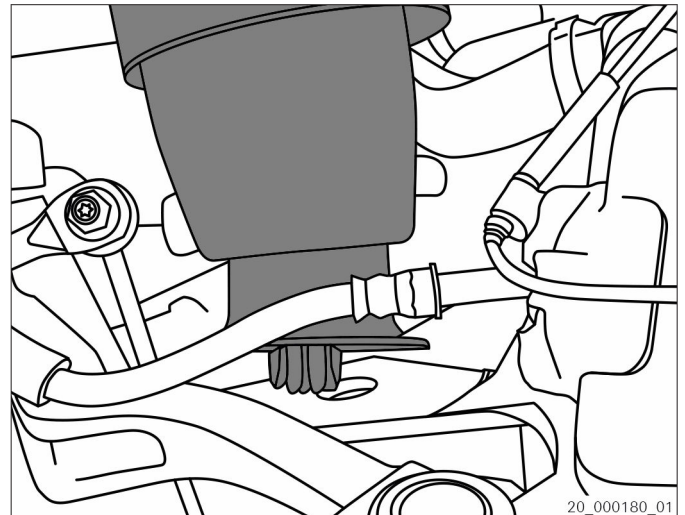

Fig. 2

3. Twist air spring to loosen it from the upper anchoring.
4. Pull air spring downwards, out of the upper anchoring.
5. Compress air spring for removal.



- Carefully loosen air line.
→ Compressed air escapes.

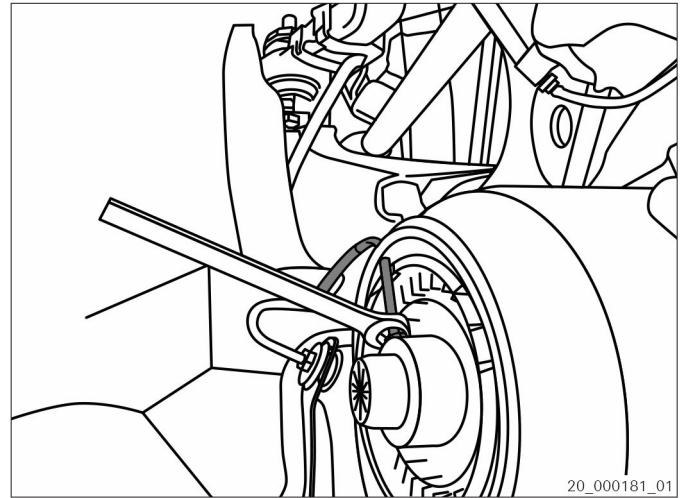



Fig. 3

- Protect connectors from contamination.

Unclipping air line

-  Do **not** cut into gaiter! A gaiter that has been cut open must not be reused.

Unclip air line from groove (1) on air spring.

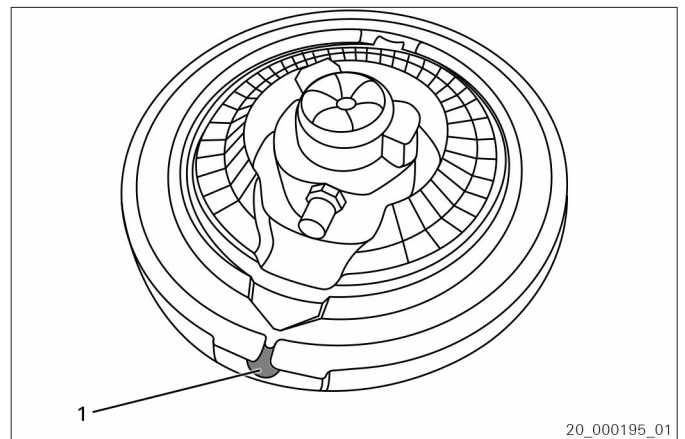

Fig. 4

1 Groove

- Remove gaiter from air spring.
- Take out air spring and dispose of it.
- Check gaiter for damages before reusing.

1.2 Mounting gaiter

Requirements:

- Check gaiter for damages. Replace damaged part. Observe the vehicle manufacturer specifications.



1. Fit gaiter to air spring.

1.3 Modifying air line

Requirements:

- Connectors are protected against contamination.

 Connecting air line to a new SACHS air spring possible only without OE nipple.

Modifying air line

1. Separate nipple (1) from clamping piece (2).

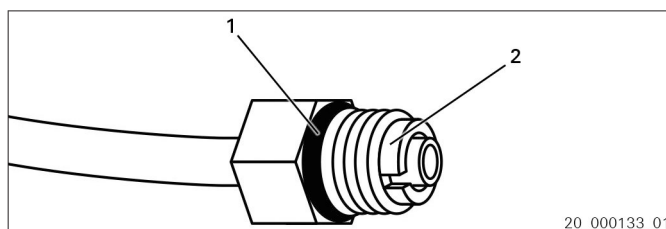

Fig. 5 Nipple with clamping piece

- 1 Nipple
- 2 Clamping piece

2. Bend open clamping piece (2).

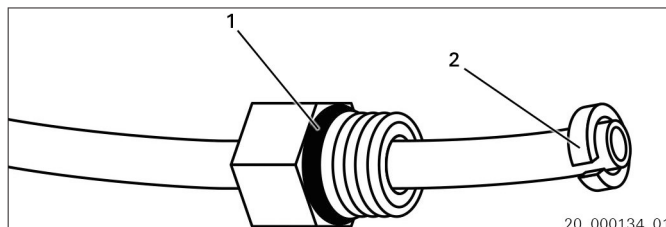

Fig. 6 Bend open clamping piece

- 1 Nipple
- 2 Clamping piece

3. Remove clamping piece (2).

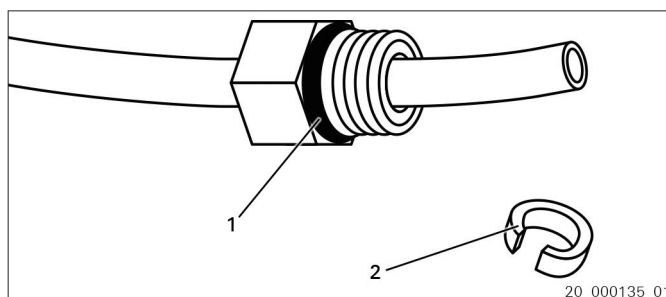

Fig. 7 Remove clamping piece

- 1 Nipple
- 2 Clamping piece



4. Remove nipple (1).

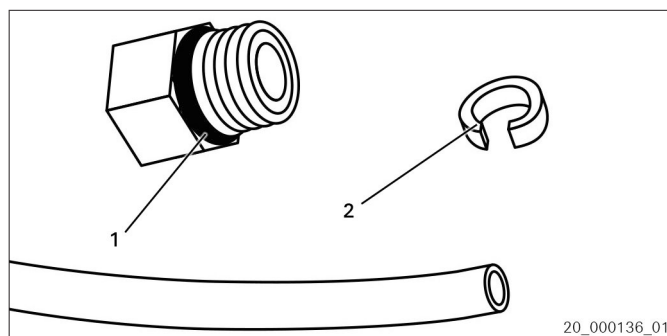

Fig. 8 Remove nipple

- 1 Nipple
- 2 Clamping piece

1.4 Connecting air line

Requirements:

- Connectors are clean.
- Connectors are protected against contamination.
- Air line has been checked for damage.

NOTICE

Material damage of air suspension possible.

Pressure loss due to scratches or cuts on air line possible.

⇒ Check air line for damage before connecting it.

⇒ Replace damaged air line.

1. Feed air line through the opening at the gaiter.
2. Remove and dispose of transport safety device (1).

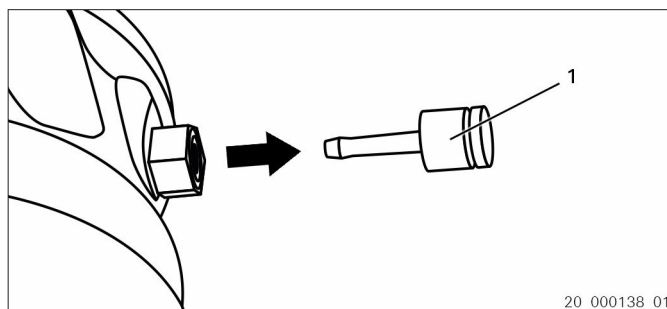

Fig. 9 Removing transport safety device

- 1 Transport safety device



3. Insert air line (1) into nipple until it abuts.

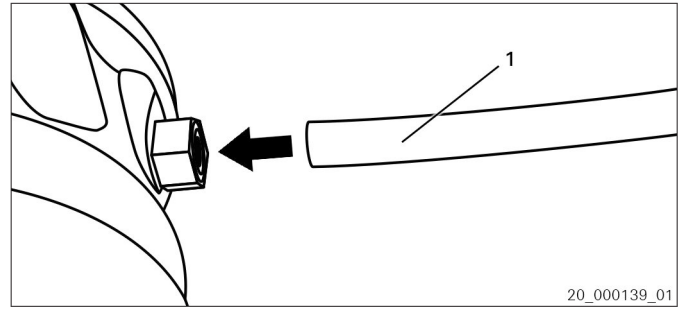

Fig. 10 Insert air line

1 Air line

4. Pull air line to check for secure fit.

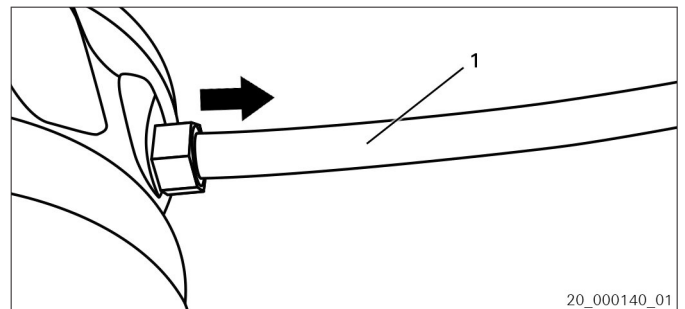

Fig. 11 Check for secure seat

1 Air line

1.5 Installing air spring, rear axle

1. Clip air line into groove at the air spring.

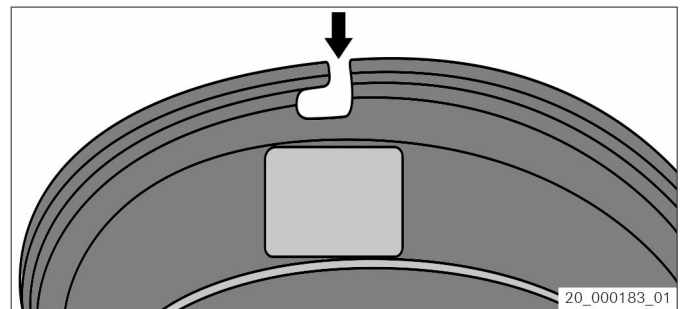

Fig. 12



2. Compress and insert air spring.

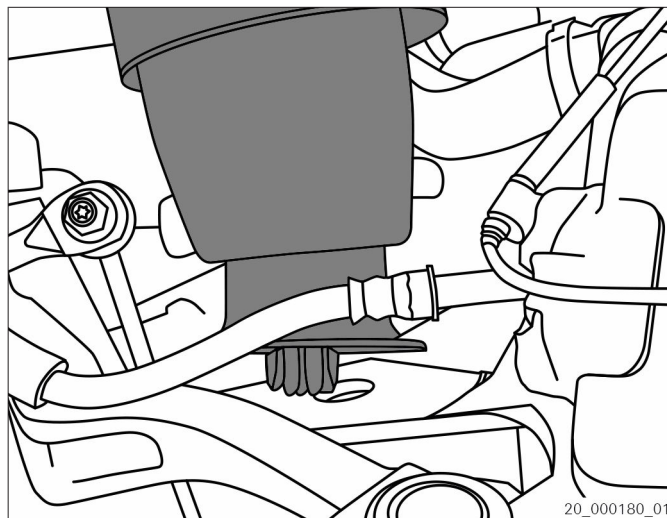

Fig. 13

3. Twist air spring to fit it into the upper anchoring.
4. Snap air spring into the lower anchoring.
5. Check whether the safety latches at the lower anchoring have securely snapped into position.

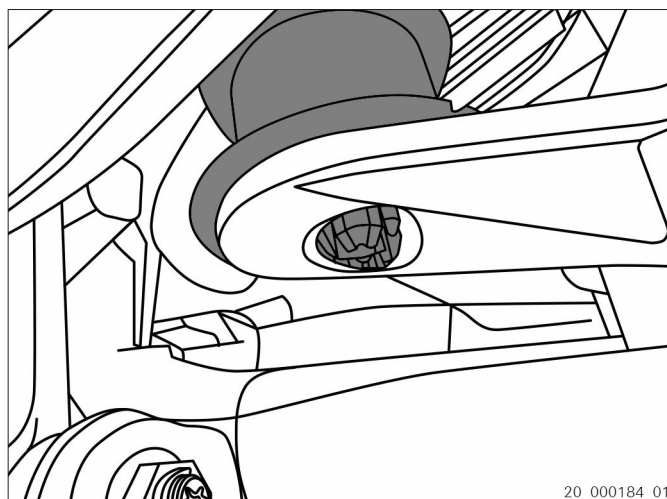

Fig. 14

1.6 Filling air suspension

Requirements:

- The vehicle is on lifting platform, wheels are freely accessible and unsupported.
1. Fill air suspension using suitable diagnostic unit. Observe the vehicle manufacturer specifications.
 2. Screw on wheel applying the appropriate tightening torque. Observe the vehicle manufacturer specifications.
 3. Lower vehicle from lifting platform.